

FORM 18111
OCTOBER 1925
PRINTED IN U. S. A.

LIST
OF
PARTS



MACHINES
Nos. 147-20 to 147-22

THE SINGER MANUFACTURING COMPANY

From the library of: Diamond Needle Corp

INDEX

	PAGE
ACCESSORIES	34
BELT GUARD	35
BENCH STAND	39
FOOT LIFTER PARTS	38
HEMMER ON SHANK	36
IRON BASE	34
KNEE LIFTER PARTS	36
LAP SEAM FELLERS	38
MACHINE No. 147-20	7
" " 147-21	16
" " 147-22	22
NUMERICAL LIST OF PARTS	41
THREAD UNWINDER No. 225397	40
" " " 225398	39

COPYRIGHT, U. S. A., 1922, 1923, 1924 AND 1925,
BY THE SINGER MANUFACTURING CO.
ALL RIGHTS RESERVED FOR ALL COUNTRIES

From the library of: **Diamond Needle Corp**

INSTRUCTIONS FOR ORDERING

In ordering from this list, use **ONLY** the **PART** number in the **FIRST** column.

The number stamped on a Sewing Machine part is in every case the number of the single part only.

Every combination of parts sent out as such has its specific number, which, although not stamped on the parts, must be used when ordering the combination.

Each number always indicates the **SAME PART** in whatever list it appears, or for whatever machine.

The letters after some of the numbers indicate the style of finish only, as follows:

- A. Hardened, Polished and Plated.
- B. Polished and Plated.
- C. Hardened only.
- D. Polished only.
- E. Soft, not Polished.
- F. Hardened and Polished.
- G.
- H. Blued.
- J. Plated only.
- K. Hardened and Plated.
- L. Brass or Gilt.
- M. Oxidized.
- P. Japanned.
- R. Parkerized.
- T. Copper-plated.

These letters **MUST BE USED** *when* they appear in the list, and **AFTER** the number *as* in the list.

In this series:

- 1 to 1500 and 50001 to 51500 are Screw Numbers.
- 1501 to 1800 are Nut Numbers.
- 1801 to 2000 are Roller Numbers.
- 2001 to 50000 and 52001 and upward are numbers of Machine Parts.

The figures in the second column refer only to the plates, illustrating the parts, and are **NOT TO BE USED** in ordering.

Parts marked with an asterisk (*) are furnished only **when** repairs are made at factory.

LIST OF PARTS COMPLETE

FOR

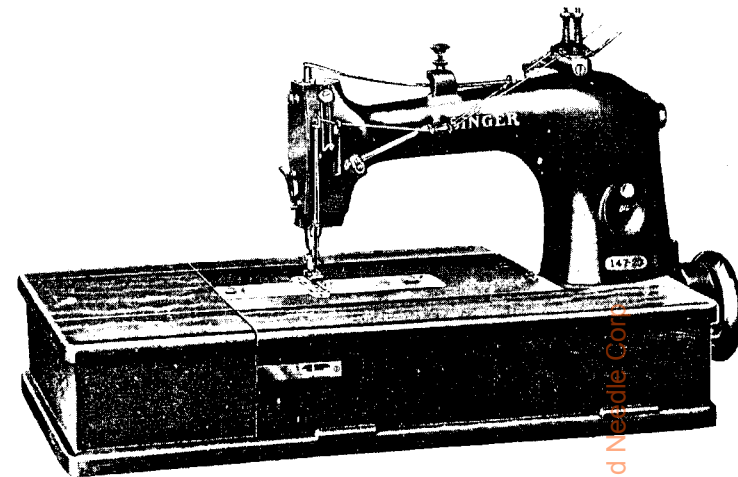

MACHINE No. 147-20

FOR TWO LINE STITCHING IN FABRICS, TWO NEEDLES, TWO LOOPERS, FOR TWO-THREAD CHAIN STITCH; FOOT LIFTER. GAUGES FROM $\frac{3}{32}$ TO $\frac{3}{8}$ INCH.

NO.	PLATE	NAME
*54001	—	Arm, upper and lower (solid) with 948D and 54034.....
42366	8901	Arm Oil Pad (braided cotton) for oiling Arm Rock Shaft Front Bearing.....
56006	8901	Arm Oil Pad (braided cotton) for oiling Arm Rock Shaft Intermediate Bearing.....
11119	8901	Arm Oil Tube with 29599, for oiling 64321
29599	8901	" " " Packing (felt).....
54002	8902	" Rock Shaft.....
64386	8901	" " " Bushing (back).....
446c	8901	" " " " " Set Screw
64388	8901	" " " " (intermediate)
423c	8901	" " " " " " Set Screw.....
52045	8901	Arm Rock Shaft Bushing Oil Pad (braided cotton).....

NO.	PLATE	NAME
54004	8901	Arm Rock Shaft Collar with two 453c
453c	8901	" " " " Set Screw
54005	8901	" " " Crank (back) with two 50083c
50083c	8901	Arm Rock Shaft Crank (back) Set Screw
64255	8911	" " " " (front) with 453c
2117	8901	" " " " " Pin
453c	8901	" " " " " Set Screw
54105	8901	" " " Flanged Bushing (front)
52045	8901	" " " " " " Oil Pad (braided cotton)
453c	8901	Arm Rock Shaft Flanged Bushing (front) Set Screw
54006	8903	Arm Rotary Shaft
54081	8901	" " " Bushing (front)
52045	8901	" " " " " Oil Pad (braided cotton)
761E	8901	Arm Rotary Shaft Bushing (front) Set Screw
54007	8902	Arm Rotary Shaft Bushing (intermediate)
54089	"	" " " " " 54007 with 42367 and 64508
61508	8902	Arm Rotary Shaft Bushing (intermediate) Oil Pad, long (braided cotton)
42367	8901	Arm Rotary Shaft Bushing (intermediate) Oil Pad, short (braided cotton)
422c	8901	Arm Rotary Shaft Bushing (intermediate) Set Screw (long)
50084c	8901	Arm Rotary Shaft Bushing (intermediate) Set Screw (short)
54008	8901	Arm Rotary Shaft Collar with two 1258c
1258c	8901	" " " " " Set Screw
54009	8902	" " " Flanged Bushing
54090	"	" " " " " 54009 with 42367 and 58039
58039	8902	Arm Rotary Shaft Flanged Bushing Oil Pad, long (braided cotton)
42367	8901	Arm Rotary Shaft Flanged Bushing Oil Pad, short (braided cotton)
159E	8901	Arm Rotary Shaft Flanged Bushing Screw
49013	8904	" " " Front Bearing Oil Pad (braided cotton)
144d	8901	Arm Rotary Shaft Screw
15196	8902	" Side Cover (back)
286d	8904	" " " " Thumb Screw
54010	8904	" " " (front)
286d	8904	" " " " Thumb Screw

NO.	PLATE	NAME
64259	8913	Balance Wheel with two 430c
430c	8901	" " " " Set Screw
54011	8903	Cloth Plate
1011F	8904	" " " Screw (left)
50473F	8904	" " " (right)
54012	8902	" " Slide (left)
54013	----	Cloth Plate Slide (left) complete, Nos. 38419, 54012 and two 725J
38419	8904	Cloth Plate Slide (left) Spring
725J	8904	" " " " " Screw
54014	8913	" " " (right) for 54015
54015	----	Cloth Plate Slide (right) complete for 54016, Nos. 38419, 54014 and two 725J
54055	8924	Cloth Plate Slide (right) for 54056
54056	----	Cloth Plate Slide (right) complete for 54059, Nos. 38419, 54055 and two 725J
54057	8924	Cloth Plate Slide (right) for 54058
54058	----	Cloth Plate Slide (right) complete for 54060, Nos. 38419, 54057 and two 725J
38419	8901	Cloth Plate Slide (right) Spring
725J	8904	" " " " " Screw
54016	----	Cloth Plate complete, for $\frac{3}{32}$ in. to $\frac{1}{2}$ in. gauges, Nos. 54011, 54013 and 54015
54059	----	Cloth Plate complete, for $\frac{3}{16}$ in. to $\frac{1}{4}$ in. gauges, Nos. 54011, 54013 and 54056
54060	----	Cloth Plate complete, for $\frac{3}{8}$ in. to $\frac{3}{8}$ in. gauges, Nos. 54011, 54013 and 54058
54104	8913	Cloth Plate Thread Guard
1235d	8904	" " " " " Screw
54017	8902	Crank Connecting Rod with 6575, 54015, 54218, 54897, 57222 and two each 896E and 1057E
50069c	8904	Crank Connecting Rod Ball Screw Stud
1516E	8904	" " " " " Nut
64268	8904	Crank Connecting Rod Ball Screw Stud Washer
*57222	----	Crank Connecting Rod Cap (lower)
896E	8904	" " " " " Screw
*54018	----	" " " " (upper)
1057E	8904	" " " " " Screw
54897	8904	" " " Oil Cup
54218	8904	" " " " Pad (braided cotton)
6575	8904	Crank Connecting Rod Oil Pad Stop Pin
64269	8913	Face Plate
46111	8911	" " Pin

NO.	PLATE	NAME
286b	8901	Face Plate Thumb Screw.....
54019	8902	Feed Bar with 50429c and two 453c....
54020	8902	" " Connection.....
57225	8904	" " Hinge Pin.....
453c	8901	" " " " Set Screw.....
54111	8902	" Connecting Rod with 1057E, 54112 and two 896E.....
*54112	—	Feed Connecting Rod Cap.....
896E	8904	" " " " Screw.....
1057E	8904	" " " Clamping Screw...
54023	8911	" " " Hinge Pin.....
21506	8904	" " " " " Collar with 457c.....
457c	8904	Feed Connecting Rod Hinge Pin Collar Set Screw.....
46080	8936	Feed Dog, for $\frac{3}{32}$ in. to $\frac{5}{32}$ in. gauges....
46081	8936	" " " $\frac{3}{16}$ in. to $\frac{3}{8}$ in. gauges....
157J	8904	" " Screw.....
50429c	8904	" " Stop Screw.....
*54024	—	" Eccentric.....
*23729	—	" " Body.....
443c	8904	" " " Set Screw.....
7071	8904	" " Clamping Washer.....
217d	8904	" " " " Screw.
61171	8904	" " Pressure Spring.....
21332	8904	" " " " Cap....
934J	8904	" " " " " Screw
54025	8906	Feed Eccentric (adjustable) complete, Nos. 217d, 934J, 1103c, 7071, 21332, 23729, 54024, 61171 and two 443c....
1103c	8904	Feed Regulating Screw.....
54026	8905	" Rocking Frame with two 453c....
57234	8911	" " " Hinge Pin.....
57235	8906	" " " " " Bushing
453c	8901	" " " " " " "
453c	8901	Feed Rocking Frame Hinge Pin Set Screw
38493	8922	Looper (back) with 590b and 38494....
54106	8933	" " closed eye.....
NOTE. When ordering Nos. 38493 or 54106, state gauge of machine for which required.		
1147c	8922	Looper (back) Set Screw.....
38494	8922	" " Thread Guard (double)...
590b	8907	" " " " Screw.....
38495	8922	" (front).....

NO.	PLATE	NAME
54107	8933	Looper (front) closed eye.....
NOTE. When ordering Nos. 38495 or 54107, state gauge of machine for which required.		
1120c	8907	Looper (front) Set Screw.....
54027	8906	" Carrier with two 171F.....
171F	8906	" " Adjusting Screw.....
54028	8906	" " Connection.....
50607J	8906	" " " Oil Plug Screw
54029	8906	" " " Shaft.....
54030	8906	" " " " Bushing
50608J	8906	" " " " " "
		Cap Screw.....
446c	8901	Looper Carrier Connection Shaft Bushing Set Screw.....
49013	8904	Looper Carrier Connection Shaft Oil Pad (braided cotton).....
54031	8906	Looper Carrier Driver with 54032 and four 391d.....
*54032	—	Looper Carrier Driver Cap.....
391d	8906	" " " " Screw.....
54033	8907	" Driving Shaft and Feed Lifting Eccentric with 227d and two 64315..
54034	8905	Looper Driving Shaft and Feed Lifting Eccentric Bracket with 761E.....
54080	8906	Looper Driving Shaft and Feed Lifting Eccentric Bracket Bushing.....
761E	8901	Looper Driving Shaft and Feed Lifting Eccentric Bracket Bushing Set Screw
948d	8906	Looper Driving Shaft and Feed Lifting Eccentric Bracket Screw.....
64315	8907	Looper Driving Shaft and Feed Lifting Eccentric Oil Hole Plug.....
227d	8907	Looper Driving Shaft and Feed Lifting Eccentric Oil Hole Screw.....
40326	8907	Looper Driving Shaft and Feed Lifting Eccentric Oil Pad (braided cotton) ...
640d	8907	Looper Driving Shaft and Feed Lifting Eccentric Screw.....
54061	8922	Looper Holder with 1120c and 1147c..
704J	8907	" " Screw.....
64319	8922	Needle Bar (hollow).....
54062	—	Needle Bar complete, for $\frac{3}{32}$ in. to $\frac{1}{4}$ in. gauges, Nos. 54064, 54065 and 64319..
54063	—	Needle Bar complete, for $\frac{3}{32}$ in. to $\frac{3}{8}$ in. gauges, Nos. 54064, 54066 and 64319..

NO.	PLATE	NAME
38456	8907	Needle Bar Bushing (lower).....
1133E	8907	" " " " Set Screw....
64320	8907	" " " (upper).....
1133E	8907	" " " " Set Screw....
64321	8907	" " Connecting Link.....
52992	8907	" " " " Hinge Stud
1520E	8907	" " " " " "
		Nut.....
64323	8907	Needle Bar Connecting Stud with 219F and two 399E.....
399E	8907	Needle Bar Connecting Stud Clamping Screw.....
54064	8922	Needle Clamp with two 1498E.....
54065	8922	" " Thread Guard, for $\frac{3}{32}$ in. to $\frac{1}{4}$ in. gauges, for 54062.....
54066	8922	Needle Clamp Thread Guard, for $\frac{3}{32}$ in. to $\frac{3}{8}$ in. gauges, for 54063.....
54067	8922	Needle Guard, for $\frac{3}{32}$ in. to $\frac{5}{32}$ in. gauges.
54068	8922	" " " $\frac{3}{16}$ in. to $\frac{5}{32}$ in. gauges.
54069	8922	" " " $\frac{5}{16}$ in. to $\frac{3}{8}$ in. gauges.
54038	8907	" " Holder.....
176D	8907	" " " Screw.....
219F	8907	" " " Screw.....
1498E	8922	" " Set Screw.....
54108	-	Oil Tube.....
54109	-	" " Bracket.....
49092	8908	" " Packing (felt).....
54110	8908	Oil Tube complete, for oiling Crank Con- necting Rod (upper bearing) Nos. 49092, 54108 and 54109.....
64330	8918	Presser Bar with 25303.....
25303	8907	" " Ball, size $\frac{1}{4}$ in.....
64331	8911	" " Bushing (lower).....
1133E	8907	" " " " Set Screw....
38456	8907	" " " (upper).....
1133E	8907	" " " " Set Screw....
54039	8908	" " Guide Bracket with 453c, 640i and 1963.....
640i	8907	Presser Bar Guide Bracket Adjusting Screw.....
11473	8908	Presser Bar Guide Bracket Guide.....
447c	8908	" " " " " Set Screw
1963	8908	" " " " Roller and Stud.....
453c	8901	Presser Bar Guide Bracket Set Screw....
57257	8911	" " Lifter.....
57258	8911	" " " Hinge Pin.....

NO.	PLATE	NAME
447c	8908	Presser Bar Lifter Hinge Pin Set Screw..
1872	8908	" " " Roller and Stud.....
1250c	8911	" " " Stop Screw.....
61017	8911	" " Lifting Bracket with 460c and 1872.....
64362	8918	Presser Bar Lifting Lever.....
61075	8911	" " " " Connecting Stud.....
460c	8910	Presser Bar Lifting Lever Connecting Stud Set Screw.....
54103	8905	Presser Bar Lifting Lever Extension.....
161D	8908	" " " " " Screw (left).....
176D	8907	Presser Bar Lifting Lever Extension Screw (right).....
802D	8908	Presser Bar Lifting Lever Hinge Screw..
54040	8905	" " Spring (flat).....
38468	8908	" " " Stud.....
26276	8911	" Foot Hinge Pin.....
46086	-	" " Plate.....
46087	-	" " Shank.....
46088	8933	Presser Foot (hinged) complete, Nos. 26276, 46086 and 46087.....
190D	8908	Presser Foot Screw.....
574J	8908	Pressure Regulating Thumb Screw.....
1539J	8908	" " " " Lock Nut.....
64336	8908	Slack Thread Controller.....
46035	8908	" " " " Clamp.....
190D	8908	" " " " Screw..
64337	8922	" " Regulator.....
54042	8908	" " " Holder with 175E and 50150c.....
175E	8908	Slack Thread Regulator Holder Clamping Screw.....
54043	8908	Slack Thread Regulator Holder Shaft
24292	8908	" " " " " "
1019c	8908	Collar with 1019c.....
1019c	8908	Slack Thread Regulator Holder Shaft Collar Set Screw.....
54044	8908	Slack Thread Regulator Holder Shaft Crank (forked) with 1253c.....
1253c	8908	Slack Thread Regulator Holder Shaft Crank Set Screw.....
50150c	8908	Slack Thread Regulator Set Screw.....
2102	8909	Tension (under thread) Disc.....

From the library of Diamond Needle Corp.

NO.	PLATE	NAME
1560c	8909	Tension (under thread) Regulating Thumb Nut.....
50148c	8909	Tension (under thread) Screw Stud.....
124687	—	“ “ “ “ “ 50148c with 1560c.....
42337	8909	Tension (under thread) Spring.....
13915	8909	“ “ “ “ Bushing..
17547	8909	“ “ “ “ Thread Guide....
54070	8931	“ (upper thread) Bracket.....
376D	8909	“ “ “ “ Screw...
2102	8909	“ “ “ “ Disc.....
1560c	8909	“ “ “ “ Regulating Thumb Nut.....
32572	8909	Tension (upper thread) Releasing Disc...
54988	8909	“ “ “ “ Pin.....
54071	8922	“ “ “ “ Shaft
54047	8909	“ “ “ “ “
		Crank with 624c.....
54048	8909	Tension (upper thread) Releasing Shaft Crank Link.....
624c	8909	Tension (upper thread) Releasing Shaft Crank Set Screw.....
54990	8909	Tension (upper thread) Releasing Shaft Spring.....
316F	8909	Tension (upper thread) Releasing Shaft Stop Screw.....
1547J	8909	Tension (upper thread) Releasing Shaft Stop Screw Nut.....
50133c	8909	Tension (upper thread) Screw Stud.....
52975	8909	“ “ “ “ Spring.....
13915	8909	“ “ “ “ Bushing..
17547	8909	“ “ “ “ Thread Guide....
38225	8909	Thread (under) Eyelet (back).....
190D	8908	“ “ “ “ Screw.....
54072	8931	“ “ “ “ (front).....
64351	8909	“ “ “ “ Nipper Cam with 465c...
465c	8909	“ “ “ “ Set Screw...
38210	8909	“ “ “ “ Spring (lower)...
38211	8909	“ “ “ “ (upper)...
46247	8909	“ “ “ “ “ Stop
176D	8907	“ “ “ “ “ Screw.....
38475	8910	“ “ “ “ Take-up with 465c.....
465c	8909	“ “ “ “ Set Screw.....
54073	8935	“ “ “ “ Staple with 38481, 54074 and two 590b.....
54049	8905	Thread (under) Take-up Staple Bracket with 460c.....

NO.	PLATE	NAME
965D	8910	Thread (under) Take-up Staple Bracket Screw.....
46041	8909	Thread (under) Take-up Staple Spring
190D	8908	“ “ “ “ “ Screw.....
54074	8935	Thread (under) Take-up Staple Thread Guard (left).....
590D	8907	Thread (under) Take-up Staple Thread Guard (left) Screw.....
38481	8910	Thread (under) Take-up Staple Thread Guard (right).....
590D	8907	Thread (under) Take-up Staple Thread Guard (right) Screw.....
38482	8910	Thread (under) Take-up Stripper.....
207D	8910	“ “ “ “ “ Screw..
64355	8910	“ “ “ “ Thread Guard (brass).....
64356	8910	Thread (under) Take-up Thread Guard Steady Pin.....
460c	8910	Thread (under) Take-up Thread Guard Steady Pin Set Screw.....
64357	8931	Thread (upper) Controller.....
207D	8910	“ “ “ “ Screw.....
46009	8931	“ “ “ “ Eyelet.....
190D	8908	“ “ “ “ Screw.....
54094	8922	“ “ “ “ Take-up.....
54095	8922	“ “ “ “ Plate.....
54716	8922	“ “ “ “ “ Spring...
1449D	8922	“ “ “ “ “ “ Screw
54096	—	Thread (upper) Take-up complete, Nos. 1449D, 54094, 54095 and 54716.....
219F	8907	Thread (upper) Take-up Set Screw.....
46089	8936	Throat Plate for 46080.....
46090	8936	“ “ “ “ 46081.....
742F	8910	“ “ “ “ Screw.....

From the library of: Diamond Needle Corp.

LIST OF PARTS COMPLETE

FOR

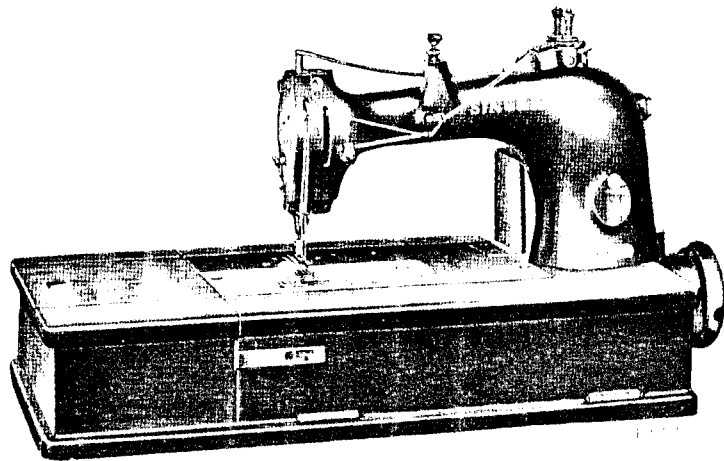

MACHINE No. 147-21

FOR STAYING SHOES. TWO NEEDLES, TWO LOOPERS, FOR TWO-THREAD CHAIN STITCH; FOOT LIFTER. GAUGES FROM $\frac{3}{32}$ TO $\frac{3}{8}$ IN.

NO.	PLATE	NAME
*54001	—	Arm, upper and lower (solid) with 948b and 54034.....
42366	8901	Arm Oil Pad (braided cotton) for oiling Arm Rock Shaft Front Bearing.....
56006	8901	Arm Oil Pad (braided cotton) for oiling Arm Rock Shaft Intermediate Bearing.....
11119	8901	Arm Oil Tube with 29599, for oiling 64321.....
29599	8901	" " " Packing (felt).....
54002	8902	" Rock Shaft.....
64386	8901	" " " Bushing (back).....
446c	8901	" " " " " Set Screw.....
64388	8901	" " " " " (intermediate).....
423c	8901	" " " " " " Set Screw.....
52045	8901	Arm Rock Shaft Bushing Oil Pad (braided cotton).....

NO.	PLATE	NAME
54004	8901	Arm Rock Shaft Collar with two 453c.....
453c	8901	" " " " " Set Screw.....
54005	8901	" " " " " Crank (back) with two 50083c.....
50083c	8901	Arm Rock Shaft Crank (back) Set Screw.....
64255	8911	" " " " " (front) with 453c.....
2117	8901	" " " " " " Pin.....
453c	8901	" " " " " " Set Screw.....
54105	8901	" " " " " Flanged Bushing (front).....
52045	8901	" " " " " " " Oil Pad (braided cotton).....
453c	8901	Arm Rock Shaft Flanged Bushing (front) Set Screw.....
54006	8903	Arm Rotary Shaft.....
54081	8901	" " " " " Bushing (front).....
52045	8901	" " " " " " " Oil Pad (braided cotton).....
761E	8901	Arm Rotary Shaft Bushing (front) Set Screw.....
54007	8902	Arm Rotary Shaft Bushing (intermediate).....
54089	—	" " " " " " " 54007 with 42367 and 64508.....
64508	8902	Arm Rotary Shaft Bushing (intermediate) Oil Pad, long (braided cotton).....
42367	8901	Arm Rotary Shaft Bushing (intermediate) Oil Pad, short (braided cotton).....
422c	8901	Arm Rotary Shaft Bushing (intermediate) Set Screw (long).....
50084c	8901	Arm Rotary Shaft Bushing (intermediate) Set Screw (short).....
54008	8901	Arm Rotary Shaft Collar with two 1258c.....
1258c	8901	" " " " " Set Screw.....
54009	8902	" " " " " Flanged Bushing.....
54090	—	" " " " " " " 54009 with 42367 and 58039.....
58039	8902	Arm Rotary Shaft Flanged Bushing Oil Pad, long (braided cotton).....
42367	8901	Arm Rotary Shaft Flanged Bushing Oil Pad, short (braided cotton).....
159F	8901	Arm Rotary Shaft Flanged Bushing Screw.....
49013	8904	" " " " " Front Bearing Oil Pad (braided cotton).....
144D	8901	Arm Rotary Shaft Screw.....
15196	8902	" Side Cover (back).....
286D	8904	" " " " " Thumb Screw.....
54010	8904	" " " " " (front).....

NO.	PLATE	NAME
286d	8904	Arm Side Cover (front) Thumb Screw...
64259	8913	Balance Wheel with two 430c.....
430c	8904	“ “ Set Screw.....
54199	8938	Cloth Plate.....
1011F	8904	“ “ Screw (left).....
50473F	8901	“ “ “ (right).....
54012	8902	“ “ Slide (left).....
54013	---	Cloth Plate Slide (left) complete, Nos. 38419, 54012 and two 725J.....
38419	8904	Cloth Plate Slide (left) Spring.....
725J	8904	“ “ “ “ “ Screw.....
54014	8913	“ “ “ (right) for 54015.....
54015	---	Cloth Plate Slide (right) complete for 54219, Nos. 38419, 54014 and two 725J.....
54055	8924	Cloth Plate Slide (right) for 54056.....
54056	---	Cloth Plate Slide (right) complete for 54200, Nos. 38419, 54055 and two 725J.....
54057	8924	Cloth Plate Slide (right) for 54058.....
54058	---	Cloth Plate Slide (right) complete for 54220, Nos. 38419, 54057 and two 725J.....
38419	8904	Cloth Plate Slide (right) Spring.....
725J	8904	“ “ “ “ “ Screw.....
54219	---	Cloth Plate complete, for $\frac{3}{2}$ in. to $\frac{5}{2}$ in. gauges, Nos. 54013, 54015 and 54199..
54200	---	Cloth Plate complete, for $\frac{3}{16}$ in. to $\frac{1}{4}$ in. gauges, Nos. 54013, 54056 and 54199..
54220	---	Cloth Plate complete, for $\frac{5}{2}$ in. to $\frac{3}{8}$ in. gauges, Nos. 54013, 54058 and 54199..
54104	8913	Cloth Plate Thread Guard.....
1235D	8904	“ “ “ “ “ Screw.....
54017	8902	Crank Connecting Rod with 6575, 54018, 54218, 54897, 57222 and two each 896E and 1057E.....
50069c	8904	Crank Connecting Rod Ball Screw Stud
1516E	8904	“ “ “ “ “ “ “ Nut.....
64268	8904	Crank Connecting Rod Ball Screw Stud Washer.....
*57222	---	Crank Connecting Rod Cap (lower).....
896E	8904	“ “ “ “ “ “ Screw.....
*54018	---	“ “ “ “ “ “ (upper).....
1057E	8904	“ “ “ “ “ “ Screw.....
54897	8901	“ “ “ “ Oil Cup.....
54218	8904	“ “ “ “ Pad (braided cotton).....
6575	8904	Crank Connecting Rod Oil Pad Stop Pin
64269	8913	Face Plate.....

NO.	PLATE	NAME
46111	8911	Face Plate Pin.....
286D	8904	“ “ Thumb Screw.....
54019	8902	Feed Bar with 50429c and two 453c.....
54020	8902	“ “ Connection.....
57225	8904	“ “ Hinge Pin.....
453c	8901	“ “ “ “ Set Screw.....
54111	8902	“ Connecting Rod with 1057E, 54112 and two 896E.....
*54112	---	Feed Connecting Rod Cap.....
896E	8904	“ “ “ “ “ Screw.....
1057E	8904	“ “ “ “ Clamping Screw...
54023	8911	“ “ “ “ Hinge Pin.....
21506	8904	“ “ “ “ “ Collar with 457c.....
457c	8904	Feed Connecting Rod Hinge Pin Collar Set Screw.....
38492	8937	Feed Dog.....
157J	8904	“ “ Screw.....
50429c	8904	“ “ Stop Screw.....
*54024	---	“ Eccentric.....
*23729	---	“ “ Body.....
443c	8904	“ “ “ “ “ Set Screw.....
7071	8904	“ “ Clamping Washer.....
217D	8904	“ “ “ “ “ Screw..
61171	8904	“ “ Pressure Spring.....
21332	8904	“ “ “ “ “ Cap.....
934J	8904	“ “ “ “ “ “ Screw
54025	8906	Feed Eccentric (adjustable) complete, Nos. 217D, 934J, 1103c, 7071, 21332, 23729, 54024, 61171 and two 443c.....
1103c	8904	Feed Regulating Screw.....
54026	8905	“ Rocking Frame with two 453c.....
57234	8911	“ “ “ “ Hinge Pin.....
57235	8906	“ “ “ “ “ “ Bushing
453c	8901	“ “ “ “ “ “ “ Set Screw.....
453c	8901	Feed Rocking Frame Hinge Pin Set Screw
54106	8933	Looper (back) closed eye.....
NOTE. When ordering No. 54106, state gauge of machine for which required.		
1147c	8922	Looper (back) Set Screw.....
54107	8933	“ (front) closed eye.....
NOTE. When ordering No. 54107, state gauge of machine for which required.		
1120c	8907	Looper (front) Set Screw.....

NO.	PLATE	NAME
51027	8906	Looper Carrier with two 171F.....
	171F 8906	“ “ Adjusting Screw.....
54028	8906	“ “ Connection.....
50607J	8906	“ “ “ Oil Plug Screw.....
54029	8906	“ “ “ Shaft.....
54030	8906	“ “ “ “ Bushing.....
50608J	8906	“ “ “ “ “.....
		Cap Screw.....
446c	8901	Looper Carrier Connection Shaft Bushing Set Screw.....
49013	8904	Looper Carrier Connection Shaft Oil Pad (braided cotton).....
54031	8906	Looper Carrier Driver with 54032 and four 391D.....
*54032	—	Looper Carrier Driver Cap.....
	391D 8906	“ “ “ “ Screw.....
54033	8907	“ Driving Shaft and Feed Lifting Eccentric with 227D and two 64315... ..
*54034	8905	Looper Driving Shaft and Feed Lifting Eccentric Bracket with 761E.....
54080	8906	Looper Driving Shaft and Feed Lifting Eccentric Bracket Bushing.....
	761E 8901	Looper Driving Shaft and Feed Lifting Eccentric Bracket Bushing Set Screw.. ..
	948D 8906	Looper Driving Shaft and Feed Lifting Eccentric Bracket Screw.....
64315	8907	Looper Driving Shaft and Feed Lifting Eccentric Oil Hole Plug.....
	227D 8907	Looper Driving Shaft and Feed Lifting Eccentric Oil Hole Screw.....
40326	8907	Looper Driving Shaft and Feed Lifting Eccentric Oil Pad (braided cotton)....
	640D 8907	Looper Driving Shaft and Feed Lifting Eccentric Screw.....
54061	8922	Looper Holder with 1120c and 1147c....
	701J 8907	“ “ Screw.....
64319	8922	Needle Bar (hollow).....
54062	—	Needle Bar complete, for $\frac{3}{8}$ in. to $\frac{1}{4}$ in. gauges, Nos. 54064, 54065 and 64319.. ..
54063	—	Needle Bar complete, for $\frac{3}{8}$ in. to $\frac{3}{8}$ in. gauges, Nos. 54064, 54066 and 64319.. ..
38456	8907	Needle Bar Bushing (lower).....
	1133E 8907	“ “ “ “ Set Screw... ..
64320	8907	“ “ “ “ (upper).....
	1133E 8907	“ “ “ “ Set Screw... ..
64321	8907	“ “ Connecting Link.....
52992	8907	“ “ “ “ Hinge Stud.....

NO.	PLATE	NAME
1520E	8907	Needle Bar Connecting Link Hinge Stud Nut.....
64323	8907	Needle Bar Connecting Stud with 219F and two 399E.....
	399E 8907	Needle Bar Connecting Stud Clamping Screw.....
54064	8922	Needle Clamp with two 1498F.....
54065	8922	“ “ Thread Guard, for $\frac{3}{8}$ in. to $\frac{1}{4}$ in. gauges, for 54062.....
54066	8922	Needle Clamp Thread Guard, for $\frac{3}{8}$ in. to $\frac{3}{8}$ in. gauges, for 54063.....
54067	8922	Needle Guard, for $\frac{3}{8}$ in. to $\frac{5}{8}$ in. gauges.. ..
54068	8922	“ “ “ $\frac{1}{8}$ in. to $\frac{3}{8}$ in. gauges.. ..
54069	8922	“ “ “ $\frac{5}{8}$ in. to $\frac{3}{8}$ in. gauges.. ..
54038	8907	“ “ Holder.....
	176D 8907	“ “ “ Screw.....
	219F 8907	“ “ “ Screw.....
	1498F 8922	“ Set Screw.....
54108	—	Oil Tube.....
54109	—	“ “ Bracket.....
49092	8908	“ “ Packing (felt).....
54110	8908	Oil Tube complete, for oiling Crank Con- necting Rod (upper bearing) Nos. 49092, 54108 and 54109.....
64330	8918	Presser Bar with 25303.....
25303	8907	“ “ Ball, size $\frac{1}{4}$ in.....
64331	8911	“ “ Bushing (lower).....
	1133E 8907	“ “ “ “ Set Screw.....
38456	8907	“ “ “ (upper).....
	1133E 8907	“ “ “ “ Set Screw.....
54039	8908	“ “ Guide Bracket with 453c, 640J and 1963.....
	640J 8907	Presser Bar Guide Bracket Adjusting Screw.....
11173	8908	Presser Bar Guide Bracket Guide.....
	447c 8908	“ “ “ “ “ Set Screw.....
	1963 8908	“ “ “ “ “ Roller and Stud.....
	453c 8901	Presser Bar Guide Bracket Set Screw....
57257	8911	“ “ Lifter.....
57258	8911	“ “ “ Hinge Pin.....
	447c 8908	“ “ “ “ “ Set Screw.. ..
	1872 8908	“ “ “ Roller and Stud.....
	1250c 8911	“ “ “ Stop Screw.....
61047	8911	“ “ Lifting Bracket with 460c and 1872.....

NO.	PLATE	NAME
64362	8918	Presser Bar Lifting Lever.....
61075	8911	“ “ “ “ Connecting Stud.....
460c	8910	Presser Bar Lifting Lever Connecting Stud Set Screw.....
54103	8905	Presser Bar Lifting Lever Extension.....
161b	8908	“ “ “ “ “ Screw (left).....
176b	8907	Presser Bar Lifting Lever Extension Screw (right).....
802b	8908	Presser Bar Lifting Lever Hinge Screw... ..
54040	8905	“ “ Spring (flat).....
38468	8908	“ “ “ Stud.....
26276	8911	“ Foot Hinge Pin.....
54201	8933	“ “ Needle Guard.....
242b	8933	“ “ “ “ Screw.....
54202	-----	“ “ Plate.....
46087	-----	“ “ Shank.....
54203	8933	Presser Foot (hinged) complete, Nos. 26276, 46087, 54202 and two each 242b and 54201.....
190b	8908	Presser Foot Screw.....
574j	8908	Pressure Regulating Thumb Screw.....
1539j	8908	“ “ “ “ Lock Nut.....
64336	8908	Slack Thread Controller.....
46035	8908	“ “ “ Clamp.....
190b	8908	“ “ “ “ Screw... ..
64337	8922	“ “ Regulator.....
54042	8908	“ “ “ “ Holder with 175E and 50150c.....
175E	8908	Slack Thread Regulator Holder Clamping Screw.....
54043	8908	Slack Thread Regulator Holder Shaft.....
24292	8908	“ “ “ “ “ “ Collar with 1019c.....
1019c	8908	Slack Thread Regulator Holder Shaft Collar Set Screw.....
54044	8908	Slack Thread Regulator Holder Shaft Crank (forked) with 1253c.....
1253c	8908	Slack Thread Regulator Holder Shaft Crank Set Screw.....
50150c	8908	Slack Thread Regulator Set Screw.....
35717	8935	Stay Guide (lower).....
35718	8935	“ “ (upper).....
35719	-----	Stay Guide complete, Nos. 35717 and 35718.....

NO.	PLATE	NAME
1199d	8935	Stay Guide Screw.....
2102	8909	Tension (under thread) Disc.....
1560c	8909	“ “ “ “ Regulating Thumb Nut.....
50148c	8909	Tension (under thread) Screw Stud.....
124687	-----	“ “ “ “ “ “ 50148c with 1560c.....
42337	8909	Tension (under thread) Spring.....
13915	8909	“ “ “ “ Bushing..
17547	8909	“ “ “ “ Thread Guide... ..
54070	8931	“ (upper thread) Bracket.....
376b	8909	“ “ “ “ “ Screw... ..
2102	8909	“ “ “ “ Disc.....
1560c	8909	“ “ “ “ Regulating Thumb Nut.....
32572	8909	Tension (upper thread) Releasing Disc... ..
54988	8909	“ “ “ “ “ Pin... ..
54071	8922	“ “ “ “ “ Shaft.....
54047	8909	“ “ “ “ “ “ Crank with 624c.....
54048	8909	Tension (upper thread) Releasing Shaft Crank Link.....
624c	8909	Tension (upper thread) Releasing Shaft Crank Set Screw.....
54990	8909	Tension (upper thread) Releasing Shaft Spring.....
316f	8909	Tension (upper thread) Releasing Shaft Stop Screw.....
1547j	8909	Tension (upper thread) Releasing Shaft Stop Screw Nut.....
50133c	8909	Tension (upper thread) Screw Stud... ..
52975	8909	“ “ “ “ Spring.....
13915	8909	“ “ “ “ “ Bushing... ..
17547	8909	“ “ “ “ Thread Guide... ..
54204	8931	Thread Lubricating Oil Cup.....
57629	8931	“ “ “ “ “ Pad (felt)... ..
54205	8931	“ “ “ “ “ Thread Guide.....
217j	8904	Thread Lubricating Oil Cup Thread Guide Screw.....
54206	-----	Thread Lubricating Oil Cup complete, Nos. 217j, 54204, 54205 and 57629... ..
38225	8909	Thread (under) Eyelet (back).....
190b	8908	“ “ “ “ “ Screw.....
54072	8931	“ “ “ “ (front).....
64351	8909	“ “ “ “ Nipper Cam with 465c... ..
465c	8909	“ “ “ “ “ Set Screw... ..

For the library of the Department of Textiles, University of Toronto

NO.	PLATE	NAME
38210	8909	Thread (under) Nipper Spring (lower)...
38211	8909	" " " " (upper)...
46247	8909	" " " " " Stop
176d	8907	" " " " " Screw....
38475	8910	" " " " Take-up with 465c.....
465c	8909	" " " " Set Screw.....
46017	8931	" " " " Staple.....
54049	8905	" " " " " Bracket with 460c.....
965d	8910	Thread (under) Take-up Staple Bracket Screw.....
46041	8909	Thread (under) Take-up Staple Spring
190d	8908	" " " " " " Screw.....
38482	8910	Thread (under) Take-up Stripper.....
207d	8910	" " " " " Screw..
64355	8910	" " " " Thread Guard (brass).....
64356	8910	Thread (under) Take-up Thread Guard Steady Pin.....
460c	8910	Thread (under) Take-up Thread Guard Steady Pin Set Screw.....
64357	8931	Thread (upper) Controller.....
207d	8910	" " " " " Screw.....
46009	8931	" " " " Eyelet.....
190d	8908	" " " " " Screw.....
54094	8922	" " " " Take-up.....
54095	8922	" " " " " Plate.....
54716	8922	" " " " " Spring....
1449d	8922	" " " " " " Screw
54096	—	Thread (upper) Take-up complete, Nos. 1449d, 54094, 54095 and 54716.....
219f	8907	Thread (upper) Take-up Set Screw.....
46011	8937	Throat Plate for 38492.....
742f	8910	" " " " " Screw.....

LIST OF PARTS COMPLETE

FOR

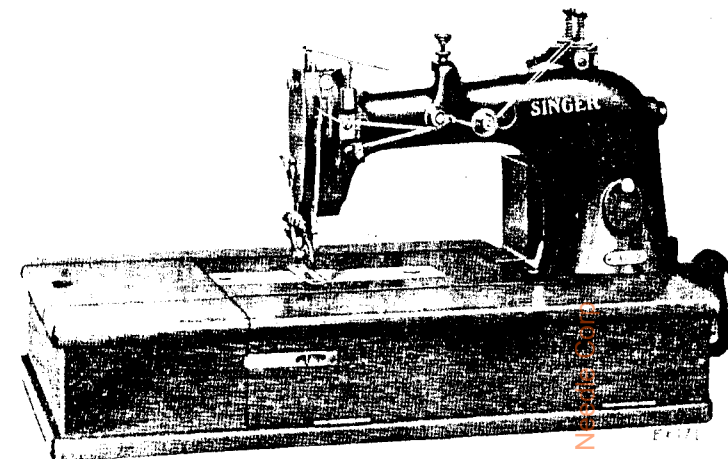

MACHINE No. 147-22

FOR VAMPING AND FOXING SHOES, TWO NEEDLES, ONE
LOOPER, GAUGES FROM $\frac{1}{32}$ TO $\frac{1}{16}$ IN. ROLLER PRESSER.

This Machine will take the place of 62-50 Machine

NO.	PLATE	NAME
*54182	—	Arm, upper and lower (solid) with 948d and 54034.....
42366	8901	Arm Oil Pad (braided cotton) for oiling Arm Rock Shaft Front Bearing.....
56006	8901	Arm Oil Pad (braided cotton) for oiling Arm Rock Shaft Intermediate Bearing
11119	8901	Arm Oil Tube with 29599, for oiling 64321
29599	8901	" " " " Packing (felt).....
54183	8932	" " " " Rock Shaft.....
64386	8901	" " " " Bushing (back).....
446c	8901	" " " " " Set Screw
64388	8901	" " " " " (intermediate).
423c	8901	" " " " " " Set Screw.....
52045	8901	Arm Rock Shaft Bushing Oil Pad (braided cotton).....

NO.	PLATE	NAME
51001	8901	Arm Rock Shaft Collar with two 453c...
453c	8901	" " " " Set Screw.....
54184	8933	" " " Crank (back) with two 50083c.....
50083c	8901	Arm Rock Shaft Crank (back) Set Screw
64255	8911	" " " " (front) with 453c.
2117	8901	" " " " " Pin.....
453c	8901	" " " " " Set Screw
54105	8901	" " " Flanged Bushing (front)
52045	8901	" " " " " " "
		Oil Pad (braided cotton).....
453c	8901	Arm Rock Shaft Flanged Bushing (front) Set Screw.....
54006	8903	Arm Rotary Shaft.....
54081	8901	" " " Bushing (front).....
52045	8901	" " " " " Oil Pad (braided cotton).....
761E	8901	Arm Rotary Shaft Bushing (front) Set Screw.....
54007	8902	Arm Rotary Shaft Bushing (intermediate)
54089	---	" " " " " "
		54007 with 42367 and 64508.....
64508	8902	Arm Rotary Shaft Bushing (intermediate) Oil Pad, long (braided cotton).....
42367	8901	Arm Rotary Shaft Bushing (intermediate) Oil Pad, short (braided cotton).....
422c	8901	Arm Rotary Shaft Bushing (intermediate) Set Screw (long).....
50084c	8901	Arm Rotary Shaft Bushing (intermediate) Set Screw (short).....
54008	8901	Arm Rotary Shaft Collar with two 1258c.
1258c	8901	" " " " Set Screw.....
54009	8902	" " " Flanged Bushing.....
54090	---	" " " " " 54009 with 42367 and 58039.....
58039	8902	Arm Rotary Shaft Flanged Bushing Oil Pad, long (braided cotton).....
42367	8901	Arm Rotary Shaft Flanged Bushing Oil Pad, short (braided cotton).....
159F	8901	Arm Rotary Shaft Flanged Bushing Screw
49013	8904	" " " Front Bearing Oil Pad (braided cotton).....
144D	8901	Arm Rotary Shaft Screw.....
15196	8902	" Side Cover (back).....
286D	8904	" " " Thumb Screw...
54010	8904	" " " (front).....
286D	8904	" " " Thumb Screw...

NO.	PLATE	NAME
54210	8924	Balance Wheel, 2 ³ / ₈ in. pulley, with two 430c.....
430c	8904	Balance Wheel Set Screw.....
54011	8903	Cloth Plate.....
1011F	8904	" " Screw (left).....
50473F	8904	" " " (right).....
54012	8902	" " Slide (left).....
54013	---	Cloth Plate Slide (left) complete, Nos. 38419, 54012 and two 725J.....
38419	8904	Cloth Plate Slide (left) Spring.....
725J	8904	" " " " " Screw....
54014	8913	" " " (right).....
54015	---	Cloth Plate Slide (right) complete, Nos. 38419, 54014 and two 725J.....
38419	8904	Cloth Plate Slide (right) Spring.....
725J	8904	" " " " " Screw...
54016	---	Cloth Plate complete, Nos. 54011, 54013 and 54015.....
54104	8913	Cloth Plate Thread Guard.....
1235D	8904	" " " " Screw.....
54017	8902	Crank Connecting Rod with 6575, 54018, 54218, 54897, 57222 and two each 896E and 1057E.....
50069c	8904	Crank Connecting Rod Ball Screw Stud
1516E	8904	" " " " " "
		Nut.....
64268	8904	Crank Connecting Rod Ball Screw Stud Washer.....
*57222	---	Crank Connecting Rod Cap (lower)...
896E	8904	" " " " " Screw
*54018	---	" " " " (upper)....
1057E	8904	" " " " " Screw
54897	8904	" " " Oil Cup.....
54218	8904	" " " Pad (braided cotton).....
6575	8904	Crank Connecting Rod Oil Pad Stop Pin
64269	8913	Face Plate.....
46111	8911	" " Pin.....
286D	8904	" " Thumb Screw.....
54019	8902	Feed Bar with 50429c and two 453c.....
54020	8902	" " Connection.....
57225	8904	" " Hinge Pin.....
453c	8901	" " " " Set Screw.....
54111	8902	" Connecting Rod with 1057E, 54112 and two 896E.....
*54112	---	Feed Connecting Rod Cap.....
896E	8904	" " " " Screw.....

NO.	PLATE	NAME
1057E	8904	Feed Connecting Rod Clamping Screw...
54023	8911	" " " Hinge Pin.....
21506	8904	" " " " " Collar with 457c.....
457c	8904	Feed Connecting Rod Hinge Pin Collar Set Screw.....
54185	8937	Feed Dog.....
157J	8904	" " Screw.....
50429c	8904	" " Stop Screw.....
*54024	----	" Eccentric.....
*23729	----	" " Body.....
443c	8904	" " " Set Screw.....
7071	8904	" " Clamping Washer.....
217D	8904	" " " " " Screw.
61171	8904	" " Pressure Spring.....
21332	8904	" " " " " Cap.....
934J	8904	" " " " " Screw
54025	8906	Feed Eccentric (adjustable) complete, Nos. 217D, 934J, 1103c, 7071, 21332, 23729, 54024, 61171 and two 443c....
1103c	8904	Feed Regulating Screw.....
54026	8905	" Rocking Frame with two 453c.....
57234	8911	" " " Hinge Pin.....
57235	8906	" " " " " Bushing
453c	8901	" " " " " " " Set Screw.....
453c	8901	Feed Rocking Frame Hinge Pin Set Screw
46066	8911	Looper with 590D and 38393.....
54027	8906	" Carrier with two 171F.....
171F	8906	" " Adjusting Screw.....
54028	8906	" " Connection.....
50607J	8906	" " " Oil Plug Screw
54029	8906	" " " Shaft.....
54030	8906	" " " " " Bushing
50608J	8906	" " " " " " Cap Screw....
446c	8901	Looper Carrier Connection Shaft Bushing Set Screw.....
49013	8904	Looper Carrier Connection Shaft Oil Pad (braided cotton).....
54031	8906	Looper Carrier Driver with 54032 and four 391D.....
*54032	----	Looper Carrier Driver Cap.....
391D	8906	" " " " " Screw.....
54033	8907	" Driving Shaft and Feed Lifting Eccentric with 227D and two 64315....

NO.	PLATE	NAME
*54034	8905	Looper Driving Shaft and Feed Lifting Eccentric Bracket with 761E.....
540S0	8906	Looper Driving Shaft and Feed Lifting Eccentric Bracket Bushing.....
761E	8901	Looper Driving Shaft and Feed Lifting Eccentric Bracket Bushing Set Screw.
948D	8906	Looper Driving Shaft and Feed Lifting Eccentric Bracket Screw.....
64315	8907	Looper Driving Shaft and Feed Lifting Eccentric Oil Hole Plug.....
227D	8907	Looper Driving Shaft and Feed Lifting Eccentric Oil Hole Screw.....
40326	8907	Looper Driving Shaft and Feed Lifting Eccentric Oil Pad (braided cotton)....
640D	8907	Looper Driving Shaft and Feed Lifting Eccentric Screw.....
54035	8907	Looper Holder with 1120c.....
704J	8907	" " Screw.....
1120c	8907	" Set Screw.....
38393	8907	" Thread Guard.....
590D	8907	" " " Screw.....
54186	8933	Needle Bar (hollow).....
54187	----	Needle Bar complete, Nos. 2273, 46070, 46166 and 54186.....
38456	8907	Needle Bar Bushing (lower).....
1133E	8907	" " " " Set Screw..
64320	8907	" " " (upper).....
1133E	8907	" " " " Set Screw..
64321	8907	" " Connecting Link.....
52992	8907	" " " " Hinge Stud
1520E	8907	" " " " " " Nut.....
64323	8907	Needle Bar Connecting Stud with 219F and two 399E.....
399E	8907	Needle Bar Connecting Stud Clamping Screw.....
46166	8933	Needle Clamp with 462F.....
46070	8933	" " Gib.....
2273	8933	" " Pin.....
462F	8933	" " Screw.....
54037	8907	" Guard.....
54038	8907	" " Holder.....
176D	8907	" " " Screw.....
219F	8907	" " " Screw.....
54188	8933	Oil Cup.....
1284D	8933	" " Regulating Screw.....
2026	8933	" " " " Spring.....

From the Library of Diamond Needle Corp.

NO.	PLATE	NAME
38100	8933	Oil Cup Packing (felt).....
54189	---	Oil Cup complete, for oiling upper thread, Nos. 1284b, 2026, 38100 and 54188.....
1423j	8933	Oil Cup Screw.....
54108	---	" Tube.....
54109	---	" " Bracket.....
49092	8908	" " Packing (felt).....
54110	8908	Oil Tube complete, for oiling Crank Con- necting Rod (upper bearing) Nos. 49092, 54108 and 54109.....
57255	8908	Presser Bar with 25303.....
25303	8907	" " Ball, size 1/4 in.....
61046	8908	" " Bushing (lower).....
1133E	8907	" " " " Set Screw....
38456	8907	" " " (upper).....
1133E	8907	" " " " Set Screw....
54039	8908	" " Guide Bracket with 453c, 640j and 1963.....
640j	8907	Presser Bar Guide Bracket Adjusting Screw.....
11173	8908	Presser Bar Guide Bracket Guide.....
447c	8908	" " " " " Set Screw
1963	8908	" " " " Roller and Stud.....
453c	8901	Presser Bar Guide Bracket Set Screw....
57257	8911	" " Lifter.....
57258	8911	" " Hinge Pin.....
447c	8908	" " " " " Set Screw..
1872	8908	" " " Roller and Stud.....
1250c	8911	" " " Stop Screw.....
61047	8911	" " Lifting Bracket with 460c and 1872.....
64362	8918	Presser Bar Lifting Lever.....
61075	8911	" " " " Connecting Stud.....
460c	8910	Presser Bar Lifting Lever Connecting Stud Set Screw.....
54103	8905	Presser Bar Lifting Lever Extension.....
161D	8908	" " " " " Screw (left).....
176D	8907	Presser Bar Lifting Lever Extension Screw (right).....
802D	8908	Presser Bar Lifting Lever Hinge Screw....
54040	8905	" " Spring (flat).....
38468	8908	" " " Stud.....
574j	8908	Pressure Regulating Thumb Screw.....

NO.	PLATE	NAME
1539j	8908	Pressure Regulating Thumb Screw Lock Nut.....
1868	8934	Roller, 7/8 in. diam., coarse, with 652D and 1528j, for 52670.....
1923	8934	Roller, 1 1/4 in. diam., coarse, with 652D and 1528j, for 52671.....
38285	8934	Roller Arm for 52670.....
38219	8934	" " " 52671.....
440F	8934	" " Adjusting Screw.....
1547j	8909	" " " " Nut.....
38302	8934	" " Bracket.....
316F	8909	" " " Screw Centre.....
1547j	8909	" " " " " Nut....
7556	8934	" " Lock Spring.....
176D	8907	" " " " Screw.....
1549j	8934	" " " " " Nut....
52669	8934	" Needle Guard (round).....
171F	8906	" " " " Set Screw.
652D	8934	" Screw.....
1528j	8934	" " Nut.....
52670	8934	Roller Presser complete, 7/8 in. coarse roller, Nos. 171F, 176D, 440F, 1549j, 1868, 7556, 38285, 38302, 52669, two 316F and three 1547j.....
52671	8934	Roller Presser complete, 1 1/4 in. coarse roller, Nos. 171F, 176D, 440F, 1549j, 1923, 7556, 38219, 38302, 52669, two 316F and three 1547j.....
190D	8908	Roller Presser Screw.....
64336	8908	Slack Thread Controller.....
46035	8908	" " " Clamp.....
190D	8908	" " " " Screw....
64337	8922	" " Regulator.....
54042	8908	" " " Holder with 175E and 50150c.....
175E	8908	Slack Thread Regulator Holder Clamping Screw.....
54043	8908	Slack Thread Regulator Holder Shaft
24292	8908	" " " " " "
		Collar with 1019c.....
1019c	8908	Slack Thread Regulator Holder Shaft Collar Set Screw.....
54044	8908	Slack Thread Regulator Holder Shaft Crank (forked) with 1253c.....
1253c	8908	Slack Thread Regulator Holder Shaft Crank Set Screw.....
50150c	8908	Slack Thread Regulator Set Screw.....

NO.	PLATE	NAME
2102	8909	Tension (under thread) Disc.....
1560c	8909	“ “ “ “ R e g u l a t i n g Thumb Nut.....
50148c	8909	Tension (under thread) Screw Stud
124687	---	“ “ “ “ “ “ 50148c with 1560c.....
42337	8909	Tension (under thread) Spring.....
13915	8909	“ “ “ “ Bushing..
17547	8909	“ “ “ “ Thread Guide....
54216	8935	“ (upper thread, automatic) Body
1508j	8935	“ “ “ “ “ “ Nut.....
54191	8935	Tension (upper thread, automatic) Body Releasing Pin.....
46383	8935	Tension (upper thread, automatic) Cam with two 1253c.....
1253c	8908	Tension (upper thread, automatic) Cam Set Screw.....
2102	8909	Tension (upper thread, automatic) Disc..
1560c	8909	“ “ “ “ “ “ R e g u l a t i n g Thumb Nut.....
32572	8909	Tension (upper thread, automatic) Releas- ing Disc.....
50106c	8935	Tension (upper thread, automatic) Screw Stud.....
46385	8935	Tension (upper thread, automatic) Screw Stud Releasing Pin.....
46386	8935	Tension (upper thread, automatic) Sepa- rating Disc.....
46387	8935	Tension (upper thread, automatic) Spring
54070	8931	“ “ “ “ Bracket.....
376d	8909	“ “ “ “ “ Screw....
2102	8909	“ “ “ “ Disc.....
1560c	8909	“ “ “ “ R e g u l a t i n g Thumb Nut.....
32572	8909	Tension (upper thread) Releasing Disc...
54988	8909	“ “ “ “ “ Pin....
54071	8922	“ “ “ “ “ S h a f t
54047	8909	“ “ “ “ “ “ Crank with 624c.....
54048	8909	Tension (upper thread) Releasing Shaft Crank Link.....
624c	8909	Tension (upper thread) Releasing Shaft Crank Set Screw.....
54990	8909	Tension (upper thread) Releasing Shaft Spring.....

NO.	PLATE	NAME
316F	8909	Tension (upper thread) Releasing Shaft Stop Screw.....
1547J	8909	Tension (upper thread) Releasing Shaft Stop Screw Nut.....
50133c	8909	Tension (upper thread) Screw Stud.....
52975	8909	“ “ “ “ Spring.....
13915	8909	“ “ “ “ “ Bushing..
17547	8909	“ “ “ “ “ Thread Guide...
38225	8909	Thread (under) Eyelet (back).....
190d	8908	“ “ “ “ “ Screw.....
38284	8909	“ “ “ “ (front).....
64351	8909	“ “ “ “ Nipper Cam with 465c...
465c	8909	“ “ “ “ “ Set Screw...
38210	8909	“ “ “ “ “ Spring (lower)...
38211	8909	“ “ “ “ “ “ (upper)...
46247	8909	“ “ “ “ “ “ “ Stop
176d	8907	“ “ “ “ “ “ Screw.....
38475	8910	“ “ “ “ “ Take-up with 465c.....
465c	8909	“ “ “ “ “ Set Screw.....
38478	8910	“ “ “ “ “ Staple with two each 590d and 38481.....
54049	8905	Thread (under) Take-up Staple Bracket with 460c.....
965d	8910	Thread (under) Take-up Staple Bracket Screw.....
46041	8909	Thread (under) Take-up Staple Spring
190d	8908	“ “ “ “ “ “ “ Screw.....
38481	8910	Thread (under) Take-up Staple Thread Guard.....
590d	8907	Thread (under) Take-up Staple Thread Guard Screw.....
46391	8935	Thread (under) Take-up Stripper.....
207d	8910	“ “ “ “ “ “ Screw..
64355	8910	“ “ “ “ “ Thread Guard (brass).....
64356	8910	Thread (under) Take-up Thread Guard Steady Pin.....
460c	8910	Thread (under) Take-up Thread Guard Steady Pin Set Screw.....
64357	8931	Thread (upper) Controller.....
207d	8910	“ “ “ “ “ Screw.....
46009	8931	“ “ “ “ “ Eyelet.....
190d	8908	“ “ “ “ “ “ Screw.....
54094	8922	“ “ “ “ “ Take-up.....
54095	8922	“ “ “ “ “ Plate.....
54716	8922	“ “ “ “ “ “ Spring...

From the library of Diatriba Nette Corp.

NO.	PLATE	NAME
1419D	8922	Thread (upper) Take-up Plate Spring Screw
54096	— —	Thread (upper) Take-up complete, Nos. 1419D, 54094, 54095 and 54716
219F	8907	Thread (upper) Take-up Set Screw
46074	8937	Throat Plate with 665D and 46075, for 54185
742F	8910	Throat Plate Screw
46075	8937	“ “ Thread Retainer
665D	8937	“ “ “ “ Screw

IRON BASE

NO.	PLATE	NAME
54091	8939	Machine Base with three each 599E, 6055 and four each 948E and 57285
599E	8940	Machine Bolt with 1524E
1524E	8940	“ “ Nut
6055	8940	“ “ “ Washer
57285	8940	“ Cushion (felt)
948E	8940	“ Screw, to fasten machine to base

ACCESSORIES

NO.	PLATE	NAME
120344	8941	Oiler (copper plated) with 120345
120345	8941	“ Spout, 5 in. long
26026	8941	Screw Driver (large)
26485	8941	“ “ (small)
38487	8941	Threading Wire
120341	8941	Tweezers (curved)
8908	8941	Wrench for 1520
19221	8941	“ “ 1516
4822	8941	“ “ 1528, 1547 and 1549

BELT GUARD

NO.	PLATE	NAME
54052	8939	Belt Guard with 453c
54053	8940	“ “ Bracket
27347	8940	“ “ Hinge Pin
57440	8940	“ “ “ “ Collar with 457c
457c	8904	“ “ “ “ Set Screw
453c	8901	“ “ Set Screw
430c	8904	“ “ Stop Screw
1520E	8907	“ “ “ “ Nut
54054	— —	Belt Guard complete, Nos. 430c, 1520E, 27347, 54052, 54053, 57440 and wood screw 1¼ in. No. 10

HEMMER ON SHANK

FOR 147-20 MACHINE

NO.	PLATE	NAME
36194	8944	Feed Dog.....
36191	4858	Hemmer on Shank.....
36006	8944	" Friction Washer.....
36192	4858	" Hinge Plate.....
1423D	8933	" " " Screw.....
1425D	8944	" " " Screw.....
36193	4858	Hemmer on Shank (hinged) complete, for towels, Nos. 1425D, 36006, 36191 and 36192.....
26276	8911	Presser Foot Hinge Pin.....
36195	—	" " Plate.....
46057	—	" " Shank.....
36196	8944	Presser Foot (hinged) complete, Nos. 26276, 36195 and 46057.....
36197	8944	Throat Plate for 36194.....
54084	8945	Cloth Plate.....
1011F	8904	" " Screw (left).....
50473F	8904	" " " (right).....
54012	8902	" " Slide (left).....
54013	—	Cloth Plate Slide (left) complete, Nos. 38419, 54012 and two 725J.....
38419	8904	Cloth Plate Slide (left) Spring.....
725J	8904	" " " " " Screw.....
54085	8945	" " " (right) with 1602E.....
1602E	8922	" " " " Bushing.....
54086	—	Cloth Plate Slide (right) complete, Nos. 54085, two 38419 and four 725J.....
38419	8904	Cloth Plate Slide (right) Spring.....
725J	8904	" " " " " Screw...
54087	—	Cloth Plate complete for 36193, Nos. 54013, 54084 and 54086.....

LAP SEAM FELLERS

FOR 147-20 MACHINE

NO.	PLATE	NAME
120350	8946	Lap Seam Feller on Shank.....
120382	8946	" " " " " for folding top edge only, for mackinaw cloth.....
120404	8947	Lap Seam Feller (adjustable) on Shank..

NO.	PLATE	NAME
120408	8947	Lap Seam Feller on Shank (right hand) for general work, for $\frac{1}{8}$ in. to $\frac{3}{8}$ in. gauges, has yielding spring.....
120409	8948	Lap Seam Feller on Shank (right hand) made short for felling curves, for $\frac{1}{8}$ in. to $\frac{3}{8}$ in. gauges, has yielding spring....
120412	8948	Lap Seam Feller on Shank (left hand) for general work, for $\frac{1}{8}$ in. to $\frac{3}{8}$ in. gauges, has yielding spring.....
1499D	8935	Lap Seam Feller Screw.....
120387	8949	Feed Dog (16 teeth) for $\frac{1}{16}$ in. to $\frac{1}{8}$ in. gauges, for 120350.....
120351	8949	Feed Dog (22 teeth) for $\frac{3}{16}$ in. to $\frac{1}{4}$ in. gauges, for 120350.....
120407	8949	Feed Dog (16 teeth) for $\frac{3}{16}$ in. and $\frac{1}{4}$ in. gauges, for 120350.....
120361	8949	Feed Dog (22 teeth) for $\frac{1}{16}$ in. and $\frac{1}{4}$ in. gauges, for 120350.....
54114	8950	Feed Dog (10 teeth to the inch) for $\frac{1}{16}$ in. to $\frac{3}{8}$ in. gauges.....
54097	8950	Feed Dog (12 teeth to the inch) for $\frac{1}{16}$ in. to $\frac{3}{8}$ in. gauges.....
54098	8950	Feed Dog (16 teeth to the inch) for $\frac{1}{16}$ in. to $\frac{3}{8}$ in. gauges.....
54099	8950	Feed Dog (18 teeth to the inch) for $\frac{1}{16}$ in. to $\frac{3}{8}$ in. gauges.....
120383	8950	Feed Dog (12 teeth to the inch) for $\frac{1}{16}$ in. and $\frac{3}{8}$ in. gauges, for 120382.....
26276	8911	Presser Foot Hinge Pin.....
120352	—	" " Plate.....
46087	—	" " Shank.....
120353	8951	Presser Foot (hinged) complete for 120350, Nos. 26276, 46087 and 120352.
26276	8911	Presser Foot Hinge Pin.....
120384	—	" " Plate.....
46087	—	" " Shank.....
120385	8951	Presser Foot (hinged) complete for 120382, Nos. 26276, 46087 and 120384
26276	8911	Presser Foot Hinge Pin.....
120405	—	" " Plate.....
46087	—	" " Shank.....
120406	8951	Presser Foot (hinged) complete for 120404, Nos. 26276, 46087 and 120405
26276	8911	Presser Foot Hinge Pin.....
54119	—	" " Plate.....
54120	—	" " Shank.....

NO.	PLATE	NAME
54121	8951	Presser Foot (hinged) complete, with left hand guide on toe, Nos. 26276, 54119 and 54120.....
26276	8911	Presser Foot Hinge Pin.....
54117	—	“ “ Plate.....
46087	—	“ “ Shank.....
54118	8951	Presser Foot (hinged) complete, with right hand guide on toe, for 120412, Nos. 26276, 46087 and 54117.....
26276	8911	Presser Foot Hinge Pin.....
54101	—	“ “ Plate.....
46087	—	“ “ Shank.....
54102	8951	Presser Foot (hinged) complete, with left hand guide on toe, Nos. 26276, 46087 and 54101.....
120354	8949	Throat Plate for 120351 and 120387.....
120362	8949	“ “ “ 120361 and 120407.....
120386	8950	“ “ “ 120383.....
54100	8950	“ “ “ 54097 to 54099 and 54114.....

FOOT LIFTER PARTS

NO.	PLATE	NAME
6439	—	Chain, 36 in. to 45 in., with 56864 and 56865.....

NOTE. When ordering No. 6439 give length required.

4879	8941	Chain Connecting Link.....
56864	8941	“ Hook (large).....
56865	8910	“ “ (small).....
126249	8939	Treadle.....
4882	8941	“ Shaft.....
126250	8941	“ Spring.....
126251	8939	“ Stand.....
126252	8939	Treadle complete, Nos. 4882, 126249 to 126251 and two wood screws 1 in. No. 16.....

KNEE LIFTER PARTS

NO.	PLATE	NAME
37563	—	Chain, length 15 in., with 56864 and 56865.....
56864	8941	Chain Hook (large).....
56865	8910	“ “ (small).....

NO.	PLATE	NAME
2763	8903	Rock Shaft.....
12242	8903	“ “ Hanger with two wood screws 1 in. No. 10.....
6335	8903	Rock Shaft Knee Arm.....
6336	—	Rock Shaft Knee Arm complete, Nos. 2766, 2767 and 6335.....
2766	8903	Rock Shaft Knee Arm Hub with 356c... 356c 8910 “ “ “ “ “ Set Screw... 2767 8903 “ “ “ Plate with 356c... 356c 8910 “ “ “ “ Set Screw... 6337 8903 “ “ Lifting Bracket with two 356c 7125 8903 “ “ “ “ Hook... 356c 8910 “ “ “ “ “ Set Screw... 356c 8910 “ “ “ “ “ Set Screw... 2770 8903 “ “ Stop Dog with 356c... 356c 8910 “ “ “ “ “ Set Screw... 23767 8903 Rock Shaft complete, Nos. 2763, 2770, 6336, 6337, 7125 and two 12242.....

BENCH STAND

NO.	PLATE	NAME
79611	—	Bench Stand with 5604, 9370, two 41538, three wood screws 1¼ in. No. 14, four 60656 and sixteen wood screws ⅝ in. No. 7.....
41538	—	Flush Bolt with Plate complete, Nos. 126247, 126248 and four brass wood screws ⅝ in. No. 4.....
126247	8952	Flush Bolt.....
126248	8952	“ “ Plate.....
60656	8952	Hinge.....
9370	8952	Slide Spring.....
5604	8952	“ “ Pin.....

THREAD UNWINDER

FOR FOUR SPOOLS

FOR 147-20 AND 147-21 MACHINES

NO.	PLATE	NAME
225395	8953	Spool Rest (for two spools) with 201018c.
225388	8953	“ “ Rod.....
200383c	8910	“ “ “ Set Screw.....
201018c	8910	“ “ “ Set Screw.....
202490	8953	“ Stand with 200383c.....

From the Library of the International Needle Industry

NO.	PLATE	NAME
225391	8953	Thread Guide.....
201696J	8910	“ “ Lock Nut.....
225392	8953	“ “ Rod with 208E and 225393
208E	8910	“ “ “ Screw.....
225393	8910	“ “ “ Washer.....
225398	8953	Thread Unwinder complete, Nos. 201696J, 202490, 225388, 225392, two 225395, four 225391 and three wood screws $\frac{7}{8}$ in. No. 13.....
27739	7234	Thread Cone (wood) for large cones.....
225390	7234	“ “ Holder, for inverted cones.

NOTE. Nos. 27739 and 225390 are used with,
but not included in, 225398.

THREAD UNWINDER

FOR THREE SPOOLS

FOR 147-22 MACHINE

NO.	PLATE	NAME
225389	7165	Spool Rest (for one spool) with 201018c..
225395	7165	“ “ (for two spools) with 201018c.
225388	7165	“ “ Rod.....
200383C	8910	“ “ “ Set Screw.....
201018c	8910	“ “ Set Screw.....
202490	7165	“ Stand with 200383c.....
225391	7165	Thread Guide.....
201696J	8910	“ “ Lock Nut.....
225392	7165	“ “ Rod with 208E and 225393
208E	8910	“ “ “ Screw.....
225393	8910	“ “ “ Washer.....
225397	7165	Thread Unwinder complete, Nos. 201696J, 202490, 225388, 225389, 225392, 225395, three 225391 and wood screws $\frac{7}{8}$ in.. No. 13.....
27739	7234	Thread Cone (wood) for large cones.....
225390	7234	“ “ Holder, for inverted cones.

NOTE. Nos. 27739 and 225390 are used with,
but not included in, 225397.

NUMERICAL LIST OF PARTS

NO.	PLATE	NAME
93H	8944	Presser Foot Tension Plate Screw for 36203.....
144D	8901	Arm Rotary Shaft Screw.....
157J	8904	Feed Dog Screw.....
159F	8901	Arm Rotary Shaft Flanged Bushing Screw.....
161D	8908	Presser Bar Lifting Lever Extension Screw (left).....
171F	8906	Looper Carrier Adjusting Screw for 54027
171F	8906	Roller Needle Guard (round) Set Screw for 52670 and 52671.....
175E	8908	Slack Thread Regulator Holder Clamping Screw for 54042.....
176D	8907	Needle Guard Holder Screw.....
176D	8907	Presser Bar Lifting Lever Extension Screw (right).....
176D	8907	Roller Arm Lock Spring Screw for 52670 and 52671.....
176D	8907	Thread (under) Nipper Spring Screw.....
190D	8908	Presser Foot Screw for 147-20 and 147-21 Machines.....
190D	8908	Roller Presser Screw for 147-22 Machine.
190D	8908	Slack Thread Controller Clamp Screw.....
190D	8908	Thread (under) Eyelet (back) Screw.....
190D	8908	“ “ Take-up Staple Spring Screw.....
190D	8908	Thread (upper) Eyelet Screw.....
207D	8910	“ (under) Take-up Stripper Screw.....
207D	8910	“ (upper) Controller Screw.....
208E	8910	“ Unwinder Thread Guide Rod Screw for 225392.....
217D	8904	Feed Eccentric Clamping Washer Screw for 54025.....
217J	8904	Thread Lubricating Oil Cup Thread Guide Screw for 54206.....
219F	8907	Needle Guard Screw for 64323.....
219F	8907	Thread (upper) Take-up Set Screw.....
227D	8907	Looper Driving Shaft and Feed Lifting Eccentric Oil Hole Screw for 54033... ..
242D	8933	Presser Foot Needle Guard Screw for 54203.....
286D	8904	Arm Side Cover (back) Thumb Screw... ..
286D	8904	“ “ “ (front) Thumb Screw... ..

Form the library of: www.needlecorp.com

NO.	PLATE	NAME
286D	8904	Face Plate Thumb Screw.....
316F	8909	Roller Arm Bracket Screw Centre for 52670 and 52671.....
316F	8909	Tension (upper thread) Releasing Shaft Stop Screw.....
356c	8910	Rock Shaft Knee Arm Hub Set Screw for 2766.....
356c	8910	Rock Shaft Knee Plate Set Screw for 2767
356c	8910	“ “ Lifting Bracket Hook Set Screw for 6337.....
356c	8910	Rock Shaft Lifting Bracket Set Screw for 6337.....
356c	8910	Rock Shaft Stop Dog Set Screw for 2770.
376D	8909	Tension (upper thread) Bracket Screw...
391D	8906	Looper Carrier Driver Cap Screw for 54031.....
399E	8907	Needle Bar Connecting Stud Clamping Screw for 64323.....
422c	8901	Arm Rotary Shaft Bushing (intermediate) Set Screw (long).....
423c	8901	Arm Rock Shaft Bushing (intermediate) Set Screw.....
430c	8904	Balance Wheel Set Screw for 54210 and 64259.....
430c	8904	Belt Guard Stop Screw for 54054.....
440F	8934	Roller Arm Adjusting Screw for 52670 and 52671.....
443c	8904	Feed Eccentric Body Set Screw for 54025
446c	8901	Arm Rock Shaft Bushing (back) Set Screw.....
446c	8901	Looper Carrier Connection Shaft Bushing Set Screw.....
447c	8908	Presser Bar Guide Bracket Guide Set Screw.....
447c	8908	Presser Bar Lifter Hinge Pin Set Screw..
453c	8901	Arm Rock Shaft Collar Set Screw for 54004.....
453c	8901	Arm Rock Shaft Crank (front) Set Screw for 64255.....
453c	8901	Arm Rock Shaft Flanged Bushing (front) Set Screw.....
453c	8901	Belt Guard Set Screw for 54052.....
453c	8901	Feed Bar Hinge Pin Set Screw for 54019.
453c	8901	“ Rocking Frame Hinge Pin Bushing Set Screw for 54026.....
453c	8901	Feed Rocking Frame Hinge Pin Set Screw for 54026.....

NO.	PLATE	NAME
453c	8901	Presser Bar Guide Bracket Set Screw for 54039.....
457c	8904	Belt Guard Hinge Pin Collar Set Screw for 57440.....
457c	8904	Feed Connecting Rod Hinge Pin Collar Set Screw for 21506.....
460c	8910	Presser Bar Lifting Lever Connecting Stud Set Screw for 61047.....
460c	8910	Thread (under) Take-up Thread Guard Steady Pin Set Screw for 54049.....
462F	8933	Needle Clamp Screw for 46166.....
465c	8909	Thread (under) Nipper Cam Set Screw for 64351.....
465c	8909	Thread (under) Take-up Set Screw for 38475.....
574J	8908	Pressure Regulating Thumb Screw.....
590D	8907	Looper (back) Thread Guard Screw for 38493.....
590D	8907	Looper Thread Guard Screw for 46066..
590D	8907	Thread (under) Take-up Staple Thread Guard (left) Screw for 54073.....
590D	8907	Thread (under) Take-up Staple Thread Guard (right) Screw for 54073.....
590D	8907	Thread (under) Take-up Staple Thread Guard Screw for 38478.....
599E	8940	Machine Bolt with 1524E, for 54091.....
624c	8909	Tension (upper thread) Releasing Shaft Crank Set Screw for 54047.....
640D	8907	Looper Driving Shaft and Feed Lifting Eccentric Screw.....
640J	8907	Presser Bar Guide Bracket Adjusting Screw for 54039.....
652D	8934	Roller Screw for 1868 and 1923.....
665D	8937	Throat Plate Thread Retainer Screw for 46074.....
704J	8907	Looper Holder Screw.....
725J	8904	Cloth Plate Slide (left) Spring Screw for 54013.....
725J	8904	Cloth Plate Slide (right) Spring Screw for 54015, 54056, 54058 and 54086.....
742F	8910	Throat Plate Screw.....
761E	8901	Arm Rotary Shaft Bushing (front) Set Screw.....
761E	8901	Looper Driving Shaft and Feed Lifting Eccentric Bracket Bushing Set Screw for 54034.....
802D	8908	Presser Bar Lifting Lever Hinge Screw..

NO.	PLATE	NAME
896E	8904	Crank Connecting Rod Cap (lower) Screw for 54017.....
896E	8904	Feed Connecting Rod Cap Screw for 54111
934J	8904	" Eccentric Pressure Spring Cap Screw for 54025.....
948D	8906	Looper Driving Shaft and Feed Lifting Eccentric Bracket Screw for 54001 and 54182.....
948E	8940	Machine Screw, to fasten machine to base, for 54091.....
965D	8910	Thread (under) Take-up Staple Bracket Screw.....
1011F	8904	Cloth Plate Screw (left).....
1019c	8908	Slack Thread Regulator Holder Shaft Collar Set Screw for 24292.....
1057E	8904	Crank Connecting Rod Cap (upper) Screw for 54017.....
1057E	8904	Feed Connecting Rod Clamping Screw for 54111.....
1103c	8904	Feed Regulating Screw for 54025.....
1120c	8907	Looper Set Screw for 54035.....
1120c	8907	" (front) Set Screw for 54061.....
1133D	8907	Needle Bar Bushing (lower) Set Screw...
1133D	8907	" " " (upper) Set Screw...
1133E	8907	Presser Bar Bushing (lower) Set Screw...
1133E	8907	" " " (upper) Set Screw...
1147c	8922	Looper (back) Set Screw for 54061.....
1235D	8904	Cloth Plate Thread Guard Screw.....
1250c	8911	Presser Bar Lifter Stop Screw.....
1253c	8908	Slack Thread Regulator Holder Shaft Crank Set Screw for 54044.....
1253c	8908	Tension (upper thread, automatic) Cam Set Screw for 46383.....
1258c	8901	Arm Rotary Shaft Collar Set Screw for 54008.....
1284D	8933	Oil Cup Regulating Screw for 54189.....
1423J	8933	" " Screw for 147-22 Machine.....
1423D	8933	Binder Hinge Plate Screw for 36199.....
1423D	8933	Hemmer Hinge Plate Screw for 36193.....
1425D	8944	Binder Hinge Screw for 36199.....
1425D	8944	Hemmer Hinge Screw for 36193.....
1449D	8922	Thread (upper) Take-up Plate Spring Screw for 54096.....
1498F	8922	Needle Set Screw for 54064.....
1499D	8935	Lap Seam Feller Screw for 147-20 Machine
1499D	8935	Stay Guide Screw for 147-21 Machine....

NO.	PLATE	NAME
1508J	8935	Tension (upper thread, automatic) Body Nut for 147-22 Machine.....
1516E	8904	Crank Connecting Rod Ball Screw Stud Nut.....
1520E	8907	Belt Guard Stop Screw Nut for 54054...
1520E	8907	Needle Bar Connecting Link Hinge Stud Nut.....
1524E	8940	Machine Bolt Nut for 599.....
1528J	8934	Roller Screw Nut for 1868 and 1923.....
1539J	8908	Pressure Regulating Thumb Screw Lock Nut.....
1547J	8909	Roller Arm Adjusting Screw Nut for 52670 and 52671.....
1547J	8909	Roller Arm Bracket Screw Centre Nut for 52670 and 52671.....
1547J	8909	Tension (upper thread) Releasing Shaft Stop Screw Nut.....
1549J	8934	Roller Arm Lock Spring Screw Nut for 52670 and 52671.....
1560c	8909	Tension (under thread) Regulating Thumb Nut for 124687.....
1560c	8909	Tension (upper thread, automatic) Regulating Thumb Nut for 147-22 Machine
1560c	8909	Tension (upper thread) Regulating Thumb Nut.....
1602E	8922	Cloth Plate Slide (right) Bushing for 54085
1868	8934	Roller, $\frac{7}{8}$ in. diam., coarse, with 652D and 1528J, for 52670.....
1872	8908	Presser Bar Lifter Roller and Stud for 61047.....
1923	8934	Roller, $1\frac{1}{4}$ in. diam., coarse, with 652D and 1528J, for 52671.....
1963	8908	Presser Bar Guide Bracket Roller and Stud for 54039.....
2026	8933	Oil Cup Regulating Screw Spring for 54189
2102	8909	Tension (under thread) Disc.....
2102	8909	Tension (upper thread, automatic) Disc for 147-22 Machine.....
2102	8909	Tension (upper thread) Disc.....
2117	8901	Arm Rock Shaft Crank (front) Pin....
2273	8933	Needle Clamp Pin for 54187.....
2656	8944	Presser Foot Tension Plate Spring for 36203.....
2763	8903	Rock Shaft for 23767.....
2766	8903	" " Knee Arm Hub with 356c, for 6336.....

NO.	PLATE	NAME
2767	8903	Rock Shaft Knee Plate with 356c, for 6336.....
2770	8903	Rock Shaft Stop Dog with 356c, for 23767
4822	8941	Wrench for 1528, 1547 and 1549 (Accessories).....
4879	8941	Chain Connecting Link.....
4882	8941	Treadle Shaft for 126252.....
5604	8952	Bench Stand Slide Spring Pin for 79611..
6055	8940	Machine Bolt Nut Washer for 54091.....
6335	8903	Rock Shaft Knee Arm for 6336.....
6336	—	Rock Shaft Knee Arm complete for 23767, Nos. 2766, 2767 and 6335.....
6337	8903	Rock Shaft Lifting Bracket with two 356c, for 23767.....
6439	—	Chain, 36 in. to 45 in., with 56864 and 56865.....
6575	8904	Crank Connecting Rod Oil Pad Stop Pin for 54017.....
7071	8904	Feed Eccentric Clamping Washer for 54025.....
7125	8903	Rock Shaft Lifting Bracket Hook for 23767.....
7556	8934	Roller Arm Lock Spring for 52670 and 52671.....
8908	8941	Wrench for 1520 (Accessories).....
9370	8952	Bench Stand Slide Spring for 79611.....
11119	8901	Arm Oil Tube with 29599, for oiling 64321
11173	8908	Presser Bar Guide Bracket Guide.....
12242	8903	Rock Shaft Hanger with two wood screws 1 in. No. 10, for 23767.....
13915	8909	Tension (under thread) Spring Bushing..
13915	8909	" (upper thread) Spring Bushing..
15106	8902	Arm Side Cover (back).....
17547	8909	Tension (under thread) Thread Guide....
17547	8909	" (upper thread) Thread Guide....
19221	8041	Wrench for 1516 (Accessories).....
21332	8904	Feed Eccentric Pressure Spring Cap for 54025.....
21506	8904	Feed Connecting Rod Hinge Pin Collar with 457c.....
*23729	—	Feed Eccentric Body for 54025.....
23767	8903	Rock Shaft complete, Nos. 2763, 2770, 6336, 6337, 7125 and two 12242.....
24292	8908	Slack Thread Regulator Holder Shaft Collar with 1019c.....
25303	8907	Presser Bar Ball, size ¼ in., for 57255 and 64330.....

NO.	PLATE	NAME
26026	8941	Screw Driver, large (Accessories).....
26276	8911	Presser Foot Hinge Pin for 36196, 46088, 54102, 54118, 54121, 54203, 120353, 120385 and 120406.....
26485	8941	Screw Driver, small (Accessories).....
27347	8940	Belt Guard Hinge Pin for 54054.....
27739	7234	Thread Unwinder Thread Cone (wood) for large cones, for 225397 and 225398
29599	8901	Arm Oil Tube Packing (felt) for 11119..
32572	8909	Tension (upper thread) Releasing Disc...
32572	8909	" (upper thread, automatic) Releasing Disc for 147-22 Machine.....
35717	8935	Stay Guide (lower) for 35719.....
35718	8935	" " (upper) for 35719.....
35719	—	Stay Guide complete for 147-21 Machine, Nos. 35717 and 35718.....
36006	8944	Binder Friction Washer for 36199.....
36006	8944	Hemmer Friction Washer for 36199.....
36191	4858	" on Shank for 36193.....
36192	8943	Binder Hinge Plate for 36199.....
36192	4858	Hemmer Hinge Plate for 36193.....
36193	4858	Hemmer on Shank (hinged) complete, for towels, for 147-20 Machine, Nos. 1425D, 36006, 36191 and 36192.....
36194	8944	Feed Dog for 36193 and 36199.....
36195	—	Presser Foot Plate for 36196.....
36196	8944	Presser Foot (hinged) complete for 36193, Nos. 26276, 36195 and 46057.....
36197	8944	Throat Plate for 36194.....
36198	8943	Binder on Shank for 36199.....
36199	8943	Binder on Shank (hinged) complete, for mattress work, for 147-20 Machine, Nos. 1425D, 36006, 36192 and 36198...
36200	—	Presser Foot Body for 36203.....
36201	8944	" " Tension Plate with 36202, for 36203.....
36202	8944	Presser Bar Tension Plate Guide Pin for 36201.....
36203	8944	Presser Foot (tension plate) complete for 36199, Nos. 93H, 2656, 36200 and 36201
37563	—	Chain, length 15 in., with 56864 and 56865
38100	8933	Oil Cup Packing (felt) for 54189.....
38210	8909	Thread (under) Nipper Spring (lower)...
38211	8909	" " " " (upper)...
38219	8934	Roller Arm for 52671.....
38225	8909	Thread (under) Eyelet (back).....

NO.	PLATE	NAME
38284	8909	Thread (under) Eyelet (front) for 147-22 Machine.....
38285	8934	Roller Arm for 52670.....
38302	8934	“ “ Bracket for 52670 and 52671.....
38393	8907	Looper Thread Guard for 46066.....
38419	8904	Cloth Plate Slide (left) Spring for 54013.....
38419	8904	“ “ “ (right) Spring for 54015, 54056, 54058 and 54086.....
38456	8907	Needle Bar Bushing (lower).....
38456	8907	Presser Bar Bushing (upper).....
38468	8908	“ “ Spring Stud.....
38475	8910	Thread (under) Take-up with 465c.....
38478	8910	“ “ “ Staple with two each 590b and 38481, for 147-22 Machine.....
38481	8910	Thread (under) Take-up Staple Thread Guard for 38478.....
38481	8910	Thread (under) Take-up Staple Thread Guard (right) for 54073.....
38482	8910	Thread (under) Take-up Stripper for 147-20 and 147-21 Machines.....
38487	8941	Threading Wire (Accessories).....
38492	8937	Feed Dog for 147-21 Machine.....
38493	8922	Looper (back) with 590b and 38494, for 147-20 Machine.....
38494	8922	Looper (back) Thread Guard (double) for 38493.....
38495	8922	Looper (front) for 147-20 Machine.....
40326	8907	Looper Driving Shaft and Feed Lifting Eccentric Oil Pad (braided cotton)....
41538	—	Bench Stand Flush Bolt with Plate complete for 79611, Nos. 126247, 126248 and four brass wood screws $\frac{5}{8}$ in. No. 4.....
42337	8909	Tension (under thread) Spring.....
42366	8901	Arm Oil Pad (braided cotton) for oiling Arm Rock Shaft Front Bearing.....
42367	8901	Arm Rotary Shaft Bushing (intermediate) Oil Pad, short (braided cotton) for 54089.....
42367	8901	Arm Rotary Shaft Flanged Bushing Oil Pad, short (braided cotton) for 54090.....
46009	8931	Thread (upper) Eyelet.....
46011	8937	Throat Plate for 38492.....
46035	8908	Slack Thread Controller Clamp.....
46041	8909	Thread (under) Take-up Staple Spring... ..
46047	8931	“ “ “ “ for 147-21 Machine.....

NO.	PLATE	NAME
46057	—	Presser Foot Shank for 36196.....
46066	8911	Looper with 590b and 38393, for 147-22 Machine.....
46070	8933	Needle Clamp Gib for 54187.....
46074	8937	Throat Plate with 665b and 46075, for 54185.....
46075	8937	Throat Plate Thread Retainer for 46074.....
46080	8936	Feed Dog, for $\frac{3}{8}$ in. to $\frac{5}{8}$ in. gauges, for 147-20 Machine.....
46081	8936	Feed Dog, for $\frac{3}{8}$ in. to $\frac{3}{8}$ in. gauges, for 147-20 Machine.....
46086	—	Presser Foot Plate for 46088.....
46087	—	“ “ Shank for 46088, 54102, 54118, 54203, 120353, 120385 and 120406.....
46088	8933	Presser Foot (hinged) complete for 147-20 Machine, Nos. 26276, 46086 and 46087.....
46089	8936	Throat Plate for 46080.....
46090	8936	“ “ “ 46081.....
46111	8911	Face Plate Pin.....
46166	8933	Needle Clamp with 462f, for 54187.....
46247	8909	Thread (under) Nipper Spring (upper) Stop.....
46383	8935	Tension (upper thread, automatic) Cam with two 1253c, for 147-22 Machine..
Nos. 46385 TO 46387 FOR 147-22 MACHINE		
46385	8935	Tension (upper thread, automatic) Screw Stud Releasing Pin.....
46386	8935	Tension (upper thread, automatic) Separating Disc.....
46387	8935	Tension (upper thread, automatic) Spring.....
46391	8935	Thread (under) Take-up Stripper for 147-22 Machine.....
49013	8904	Arm Rotary Shaft Front Bearing Oil Pad (braided cotton).....
49013	8904	Looper Carrier Connection Shaft Oil Pad (braided cotton).....
49092	8908	Oil Tube Packing (felt) for 54110.....
50069c	8904	Crank Connecting Rod Ball Screw Stud..
50083c	8901	Arm Rock Shaft Crank (back) Set Screw for 54005 and 54184.....
50084c	8901	Arm Rotary Shaft Bushing (intermediate) Set Screw (short).....
50106c	8935	Tension (upper thread, automatic) Screw Stud for 147-22 Machine.....
50133c	8909	Tension (upper thread) Screw Stud.....

From the Library of the National Needle Center

NO.	PLATE	NAME
50148c	8909	Tension (under thread) Screw Stud for 124687.....
50150c	8908	Slack Thread Regulator Set Screw for 54042.....
50429c	8904	Feed Dog Stop Screw for 54019.....
50473F	8904	Cloth Plate Screw (right).....
50607J	8906	Looper Carrier Connection Oil Plug Screw
50608J	8906	“ “ “ Shaft Bushing Cap Screw.....
52045	8901	Arm Rock Shaft Bushing Oil Pad (braided cotton).....
52045	8901	Arm Rock Shaft Flanged Bushing (front) Oil Pad (braided cotton).....
52045	8901	Arm Rotary Shaft Bushing (front) Oil Pad (braided cotton).....
52669	8934	Roller Needle Guard (round) for 52670 and 52671.....
52670	8934	Roller Presser complete, $\frac{1}{8}$ in. coarse roller, for 147-22 Machine, Nos. 171F, 176D, 440F, 1549J, 1868, 7556, 38285, 38302, 52669, two 316F and three 1547J
52671	8934	Roller Presser complete, $1\frac{1}{4}$ in. coarse roller, for 147-22 Machine, Nos. 171F, 176D, 440F, 1549J, 1923, 7556, 38219, 38302, 52669, two 316F and three 1547J
52975	8909	Tension (upper thread) Spring.....
52992	8907	Needle Bar Connecting Link Hinge Stud
*54001	—	Arm, upper and lower (solid) with 948D and 54034, for 147-20 and 147-21 Machines.....
54002	8902	Arm Rock Shaft for 147-20 and 147-21 Machines.....
54004	8901	Arm Rock Shaft Collar with two 453c...
54005	8901	“ “ “ Crank (back) with two 50083c, for 147-20 and 147-21 Machines
54006	8903	Arm Rotary Shaft.....
54007	8902	“ “ “ Bushing (intermediate) for 54089.....
54008	8901	Arm Rotary Shaft Collar with two 1258c.
54009	8902	“ “ “ Flanged Bushing for 54090.....
54010	8904	Arm Side Cover (front).....
54011	8903	Cloth Plate for 54016, 54059 and 54060..
54012	8902	“ “ Slide (left) for 54013.....

NO.	PLATE	NAME
54013	—	Cloth Plate Slide (left) complete for 54016, 54059, 54060, 54087, 54200, 54219 and 54220, Nos. 38419, 54012 and two 725J.....
54014	8913	Cloth Plate Slide (right) for 54015.....
54015	—	Cloth Plate Slide (right) complete for 54016 and 54219, Nos. 38419, 54014 and two 725J.....
54016	—	Cloth Plate complete for 147-22 Machine and for $\frac{3}{8}$ in. to $\frac{5}{8}$ in. gauges for 147-20 Machine, Nos. 54011, 54013 and 54015
54017	8902	Crank Connecting Rod with 6575, 54018, 54218, 54897, 57222 and two each 896E and 1057E.....
*54018	—	Crank Connecting Rod Cap (upper) for 54017.....
54019	8902	Feed Bar with 50429c and two 453c.....
54020	8902	“ “ Connection.....
54023	8911	“ Connecting Rod Hinge Pin.....
*54024	—	“ Eccentric for 54025.....
54025	8906	Feed Eccentric (adjustable) complete, Nos. 217D, 934J, 1103c, 707E, 21332, 23729, 54024, 61171 and two 443c.....
54026	8905	Feed Rocking Frame with two 453c.....
54027	8906	Looper Carrier with two 171F.....
54028	8906	“ “ Connection.....
54029	8906	“ “ “ Shaft.....
54030	8906	“ “ “ “ Bushing
54031	8906	“ “ Driver with 54032 and four 391D.....
*54032	—	Looper Carrier Driver Cap for 54031....
54033	8907	“ Driving Shaft and Feed Lifting Eccentric with 227D and two 64315....
*54034	8905	Looper Driving Shaft and Feed Lifting Eccentric Bracket with 761E, for 54001 and 54182.....
54035	8907	Looper Holder with 1120c, for 147-22 Machine.....
54037	8907	Needle Guard for 147-22 Machine.....
54038	8907	“ “ Holder.....
54039	8908	Presser Bar Guide Bracket with 453c, 640J and 1963.....
54040	8905	Presser Bar Spring (flat).....
54042	8908	Slack Thread Regulator Holder with 175E and 50150c.....
54043	8908	Slack Thread Regulator Holder Shaft

NO.	PLATE	NAME
54044	8908	Slack Thread Regulator Holder Shaft Crank (forked) with 1253c.....
54047	8909	Tension (upper thread) Releasing Shaft Crank with 624c.....
54048	8909	Tension (upper thread) Releasing Shaft Crank Link.....
54049	8905	Thread (under) Take-up Staple Bracket with 460c.....
54052	8939	Belt Guard with 453c, for 54054.....
54053	8940	“ “ Bracket for 54054.....
54054	—	Belt Guard complete, Nos. 430c, 1520e, 27347, 54052, 54053, 57440 and wood screw 1¼ in. No. 10.....
54055	8924	Cloth Plate Slide (right) for 54056.....
54056	—	Cloth Plate Slide (right) complete for 54059, Nos. 38419, 54055 and two 725J.....
54057	8924	Cloth Plate Slide (right) for 54058.....
54058	—	Cloth Plate Slide (right) complete for 54060 and 54220, Nos. 38419, 54057 and two 725J.....
54059	—	Cloth Plate complete, for ⅜ in. to ¼ in. gauges, for 147-20 Machine, Nos. 54011, 54013 and 54056.....
54060	—	Cloth Plate complete, for ⅝ in. to ⅜ in. gauges, for 147-20 Machine, Nos. 54011, 54013 and 54058.....
54061	8922	Looper Holder with 1120c and 1147c, for 147-20 and 147-21 Machines.....
54062	—	Needle Bar complete, for ⅜ in. to ¼ in. gauges, for 147-20 and 147-21 Machines, Nos. 54064, 54065 and 64319.....
54063	—	Needle Bar complete, for ⅝ in. to ⅜ in. gauges, for 147-20 and 147-21 Machines, Nos. 54064, 54066 and 64319.....
54064	8922	Needle Clamp with two 1498F, for 54062 and 54063.....
54065	8922	Needle Clamp Thread Guard, for ⅝ in. to ¼ in. gauges, for 54062.....
54066	8922	Needle Clamp Thread Guard, for ⅝ in. to ⅜ in. gauges, for 54063.....
54067	8922	Needle Guard, for ⅝ in. to ⅝ in. gauges, for 147-20 and 147-21 Machines.....
54068	8922	Needle Guard, for ⅜ in. to ⅝ in. gauges, for 147-20 and 147-21 Machines.....
54069	8922	Needle Guard, for ⅜ in. to ⅜ in. gauges, for 147-20 and 147-21 Machines.....
54070	8931	Tension (upper thread) Bracket.....

NO.	PLATE	NAME
54071	8922	Tension (upper thread) Releasing Shaft.....
54072	8931	Thread (under) Eyelet (front) for 147-20 and 147-21 Machines.....
54073	8935	Thread (under) Take-up Staple with 38481, 54074 and two 590D, for 147-20 Machine.....
54074	8935	Thread (under) Take-up Staple Thread Guard (left) for 54073.....
54080	8906	Looper Driving Shaft and Feed Lifting Eccentric Bracket Bushing.....
54081	8901	Arm Rotary Shaft Bushing (front).....
54084	8945	Cloth Plate for 54087.....
54085	8945	“ “ Slide (right) with 1602E, for 54086.....
54086	—	Cloth Plate Slide (right) complete for 54087, Nos. 54085, two 38419 and four 725J.....
54087	—	Cloth Plate complete for 36193 and 36199, Nos. 54013, 54084 and 54086.....
54089	—	Arm Rotary Shaft Bushing (intermediate) 54007 with 42367 and 64508.....
54090	—	Arm Rotary Shaft Flanged Bushing 54009 with 42367 and 58039.....
54091	8939	Machine Base with three each 599E, 6055 and four each 948E and 57283.....
54094	8922	Thread (upper) Take-up for 54096.....
54095	8922	“ “ “ Plate for 54096.....
54096	—	Thread (upper) Take-up complete, Nos. 1449D, 54094, 54095 and 54716.....
54097	8950	Feed Dog (12 teeth to the inch) for ⅜ in. to ⅜ in. gauges, for Lap Seam Feller.....
54098	8950	Feed Dog (16 teeth to the inch) for ⅜ in. to ⅜ in. gauges, for Lap Seam Feller.....
54099	8950	Feed Dog (18 teeth to the inch) for ⅜ in. to ⅜ in. gauges, for Lap Seam Feller.....
54100	8950	Throat Plate for 54097 to 54099 and 54114.....
54101	—	Presser Foot Plate for 54102.....
54102	8951	Presser Foot (hinged) complete, with left hand guide on toe, for Lap Seam Feller, Nos. 26276, 46087 and 54101.....
54103	8905	Presser Bar Lifting Lever Extension.....
54104	8913	Cloth Plate Thread Guard.....
54105	8901	Arm Rock Shaft Flanged Bushing (front).....
54106	8933	Looper (back) closed eye, for 147-20 and 147-21 Machines.....
54107	8933	Looper (front) closed eye, for 147-20 and 147-21 Machines.....

NO.	PLATE	NAME
54108	---	Oil Tube for 54110.....
54109	---	“ “ Bracket for 54110.....
54110	8908	Oil Tube complete, for oiling Crank Connecting Rod (upper bearing) Nos. 49092, 54108 and 54109.....
54111	8902	Feed Connecting Rod with 1057c, 54112 and two 896e.....
*54112	---	Feed Connecting Rod Cap for 54111.....
54114	8950	“ Dog (10 teeth to the inch) for $\frac{3}{8}$ in. to $\frac{3}{4}$ in. gauges, for Lap Seam Feller..
54117	---	Presser Foot Plate for 54118.....
54118	8951	Presser Foot (hinged) complete, with right hand guide on toe, for 120412, Nos. 26276, 46087 and 54117.....
54119	---	Presser Foot Plate for 54121.....
54120	---	“ “ Shank for 54121.....
54121	8951	Presser Foot (hinged) complete, with left hand guide on toe, for Lap Seam Feller, Nos. 26276, 54119 and 54120.....
Nos. 54182 TO 54185 FOR 147-22 MACHINE		
*54182	---	Arm, upper and lower (solid) with 948d and 54034.....
54183	8932	Arm Rock Shaft.....
54184	8933	“ “ “ Crank (back) with two 50083c.....
54185	8937	Feed Dog.....
54186	8933	Needle Bar (hollow) for 54187.....
54187	---	Needle Bar complete for 147-22 Machine, Nos. 2273, 46070, 46166 and 54186.....
54188	8933	Oil Cup for 54189.....
54189	---	Oil Cup complete, for oiling upper thread, for 147-22 Machine, Nos. 1284d, 2026, 38100 and 54188.....
54191	8935	Tension (upper thread, automatic) Body Releasing Pin for 147-22 Machine....
54199	8938	Cloth Plate for 54200, 54219 and 54220..
54200	---	Cloth Plate complete, for $\frac{1}{8}$ in. to $\frac{1}{4}$ in. gauges, for 147-21 Machine, Nos. 54013, 54056 and 54199.....
54201	8933	Presser Foot Needle Guard for 54203....
54202	---	“ “ Plate for 54203.....
54203	8933	Presser Foot (hinged) complete for 147-21 Machine, Nos. 26276, 46087, 54202 and two each 242d and 54201.....

NO.	PLATE	NAME
54204	8931	Thread Lubricating Oil Cup for 54206... .
54205	8931	“ “ “ “ Thread Guide for 54206.....
54206	---	Thread Lubricating Oil Cup complete for 147-21 Machine, Nos. 2173, 54204, 54205 and 57629.....
54210	8924	Balance Wheel, $2\frac{5}{8}$ in. pulley, with two 430c, for 147-22 Machine.....
54216	8935	Tension (upper thread, automatic) Body for 147-22 Machine.....
54218	8904	Crank Connecting Rod Oil Pad (braided cotton) for 54017.....
54219	---	Cloth Plate complete, for $\frac{3}{2}$ in. to $\frac{5}{2}$ in. gauges, for 147-21 Machine, Nos. 54013, 54015 and 54199.....
54220	---	Cloth Plate complete, for $\frac{3}{2}$ in. to $\frac{3}{4}$ in. gauges, for 147-21 Machine, Nos. 54013, 54058 and 54199.....
54716	8922	Thread (upper) Take-up Plate Spring for 54096.....
54897	8904	Crank Connecting Rod Oil Cup for 54017
54988	8909	Tension (upper thread) Releasing Pin...
54990	8909	“ “ “ “ Shaft Spring.....
56006	8901	Arm Oil Pad (braided cotton) for oiling Arm Rock Shaft Intermediate Bearing
56864	8941	Chain Hook (large) for 6439 and 37563..
56865	8910	“ “ (small) for 6439 and 37563..
*57222	---	Crank Connecting Rod Cap (lower) for 54017.....
57225	8904	Feed Bar Hinge Pin.....
57234	8911	“ Rocking Frame Hinge Pin.....
57235	8906	“ “ “ “ “ Bushing..
57255	8908	Presser Bar with 25303, for 147-22 Machine.....
57257	8911	Presser Bar Lifter.....
57258	8911	“ “ “ Hinge Pin.....
57285	8940	Machine Cushion (felt) for 54091.....
57440	8940	Belt Guard Hinge Pin Collar with 457c, for 54054.....
57629	8931	Thread Lubricating Oil Cup Pad (felt) for 54206.....
58039	8902	Arm Rotary Shaft Flanged Bushing Oil Pad, long (braided cotton) for 54090..
60656	8952	Bench Stand Hinge for 79611.....
61046	8908	Presser Bar Bushing (lower) for 147-22 Machine.....

NO.	PLATE	NAME
61047	8911	Presser Bar Lifting Bracket with 460c and 1872.....
61075	8911	Presser Bar Lifting Lever Connecting Stud
61171	8904	Feed Eccentric Pressure Spring for 54025
64255	8911	Arm Rock Shaft Crank (front) with 453c
64259	8913	Balance Wheel with two 430c, for 147-20 and 147-21 Machines.....
64268	8904	Crank Connecting Rod Ball Screw Stud Washer.....
64269	8913	Face Plate.....
64315	8907	Looper Driving Shaft and Feed Lifting Eccentric Oil Hole Plug for 54033.....
64319	8922	Needle Bar (hollow) for 54062 and 54063
64320	8907	“ “ Bushing (upper).....
64321	8907	“ “ Connecting Link.....
64323	8907	“ “ “ Stud with 219F and two 399E.....
64330	8918	Presser Bar with 25303, for 147-20 and 147-21 Machines.....
64331	8911	Presser Bar Bushing (lower) for 147-20 and 147-21 Machines.....
64336	8908	Slack Thread Controller.....
64337	8922	“ “ Regulator.....
64351	8909	Thread (under) Nipper Cam with 465c...
64355	8910	“ “ Take-up Thread Guard (brass).....
64356	8910	Thread (under) Take-up Thread Guard Steady Pin.....
64357	8931	Thread (upper) Controller.....
64362	8918	Presser Bar Lifting Lever.....
64386	8901	Arm Rock Shaft Bushing (back).....
64388	8901	“ “ “ “ (intermediate).....
64508	8902	“ Rotary Shaft Bushing (intermediate) Oil Pad (long) braided cotton, for 54089
79611	—	Bench Stand with 5604, 9370, two 41538, three wood screws 1¼ in. No. 14, four 60656 and sixteen wood screws ⅝ in. No. 7.....
120341	8941	Tweezers, curved (Accessories).....
120344	8941	Oiler (copper plated) with 120345 (Accessories).....
120345	8941	Oiler Spout, 5 in. long, for 120344.....
120350	8946	Lap Seam Feller on Shank for 147-20 Machine.....
120351	8949	Feed Dog (22 teeth) for ⅜ in. to ⅞ in. gauges, for 120350.....
120352	—	Presser Foot Plate for 120353.....

NO.	PLATE	NAME
120353	8951	Presser Foot (hinged) complete for 120350, Nos. 26276, 46087 and 120352
120354	8949	Throat Plate for 120351 and 120387.....
120361	8949	Feed Dog (22 teeth) for ⅜ in. and ¼ in. gauges, for 120350.....
120362	8949	Throat Plate for 120361 and 120407....
120382	8946	Lap Seam Feller on Shank, for folding top edge only, for mackinaw cloth, for 147-20 Machine.....
120383	8950	Feed Dog (12 teeth to the inch) for ⅜ in. and ⅝ in. gauges, for 120382.....
120384	—	Presser Foot Plate for 120385.....
120385	8951	Presser Foot (hinged) complete for 120382, Nos. 26276, 46087 and 120384
120386	8950	Throat Plate for 120383.....
120387	8949	Feed Dog (16 teeth) for ⅜ in. to ⅞ in. gauges, for 120350.....
120404	8947	Lap Seam Feller (adjustable) on Shank for 147-20 Machine.....
120405	—	Presser Foot Plate for 120406.....
120406	8951	Presser Foot (hinged) complete for 120404, Nos. 26276, 46087 and 120405
120407	8949	Feed Dog (16 teeth) for ⅜ in. and ¼ in. gauges, for 120350.....
120408	8947	Lap Seam Feller on Shank (right hand) for general work, for ⅜ in. to ⅝ in. gauges, has yielding spring, for 147-20 Machine.....
120409	8948	Lap Seam Feller on Shank (right hand) made short for felling curves, for ⅜ in. to ⅝ in. gauges, has yielding spring, for 147-20 Machine.....
120412	8948	Lap Seam Feller on Shank (left hand) for general work, for ⅜ in. to ⅝ in. gauges, has yielding spring, for 147-20 Machine
124687	—	Tension (under thread) Screw Stud 50148c with 1560c.....
126247	8952	Bench Stand Flush Bolt for 41538.....
126248	8952	“ “ “ “ Plate for 41538.
Nos. 126249 TO 126251 FOR 126252		
126249	8939	Treadle.....
126250	8941	“ Spring.....
126251	8939	“ Stand.....
126252	8939	Treadle complete, Nos. 4882, 126249 to 126251 and two wood screws 1 in. No. 16.....

NO.	PLATE	NAME
200383c	8910	Thread Unwinder Spool Rest Rod Set Screw for 202490.....
201018c	8910	Thread Unwinder Spool Rest Set Screw for 225389 and 225395.....
201696j	8910	Thread Unwinder Thread Guide Lock Nut for 225397 and 225398.....
202490	8953	Thread Unwinder Spool Stand with 200383c, for 225397 and 225398.....
225388	8953	Thread Unwinder Spool Rest Rod for 225397 and 225398.....
225389	7165	Thread Unwinder Spool Rest (for one spool) with 201018c, for 225397.....
Nos. 225390 TO 225392 FOR 225397 AND 225398		
225390	7234	Thread Unwinder Thread Cone Holder, for inverted cones.....
225391	8953	Thread Unwinder Thread Guide.....
225392	8953	“ “ “ “ Rod with 208k and 225393.....
225393	8910	Thread Unwinder Thread Guide Rod Washer for 225392.....
225395	8953	Thread Unwinder Spool Rest (for two spools) with 201018c, for 225397 and 225398.....
225397	7165	Thread Unwinder complete, for three spools, for 147-22 Machine, Nos. 201696j, 202490, 225388, 225389, 225392, 225395, three 225391 and wood screws $\frac{7}{8}$ in. No. 13.....
225398	8953	Thread Unwinder complete, for four spools, for 147-20 and 147-21 Machines, Nos. 201696j, 202490, 225388, 225392, two 225395, four 225391 and three wood screws $\frac{7}{8}$ in. No. 13.....

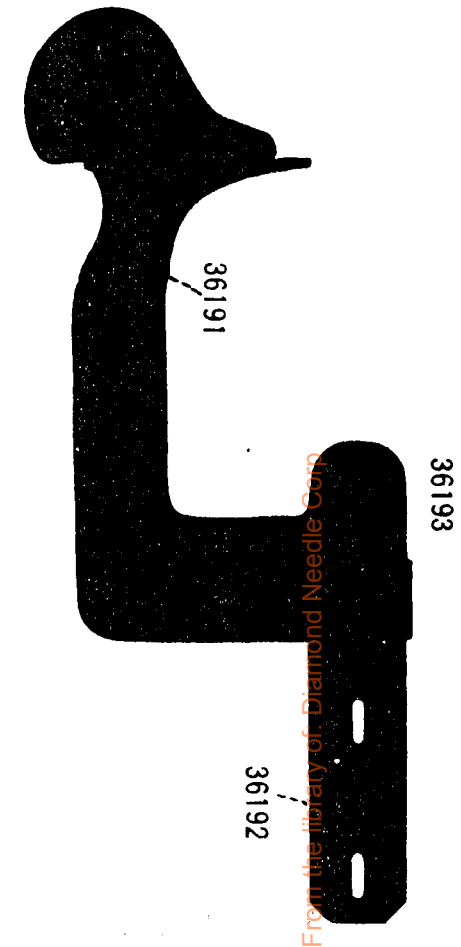

PLATE 7165—ONE-FOURTH SIZE

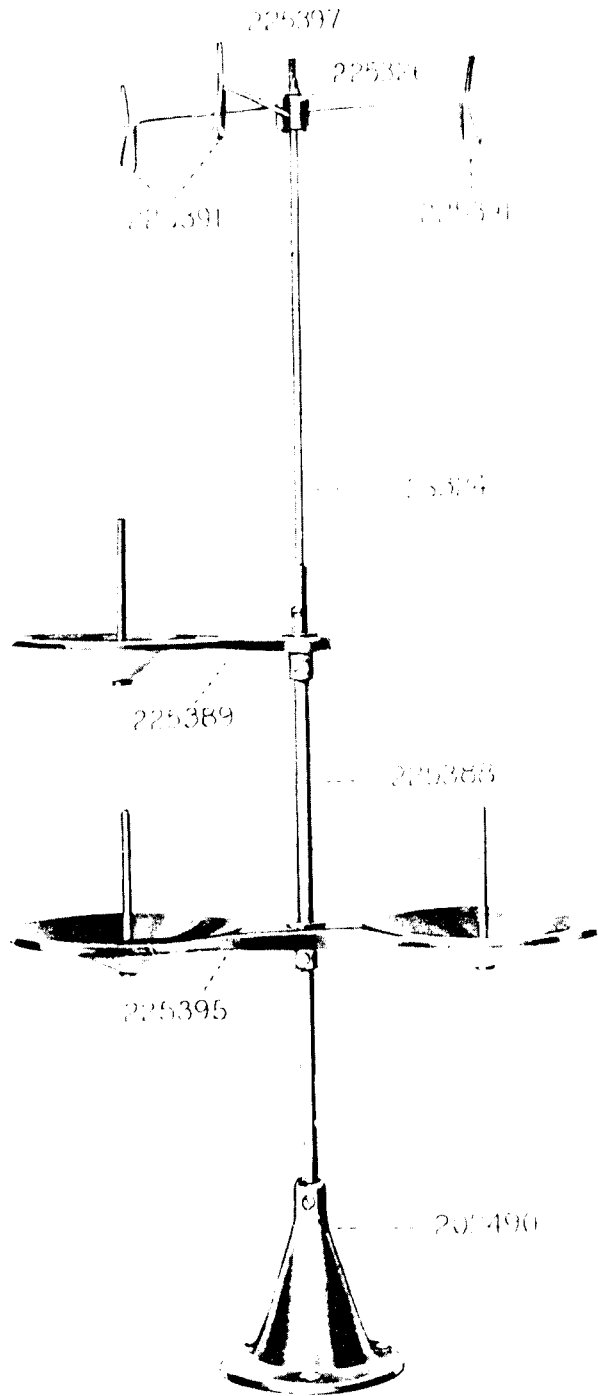
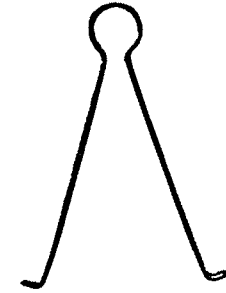

PLATE 7234—ONE-HALF SIZE

27739



225390



From the library of: Diamond Needle Corp

PLATE 8901—FULL SIZE

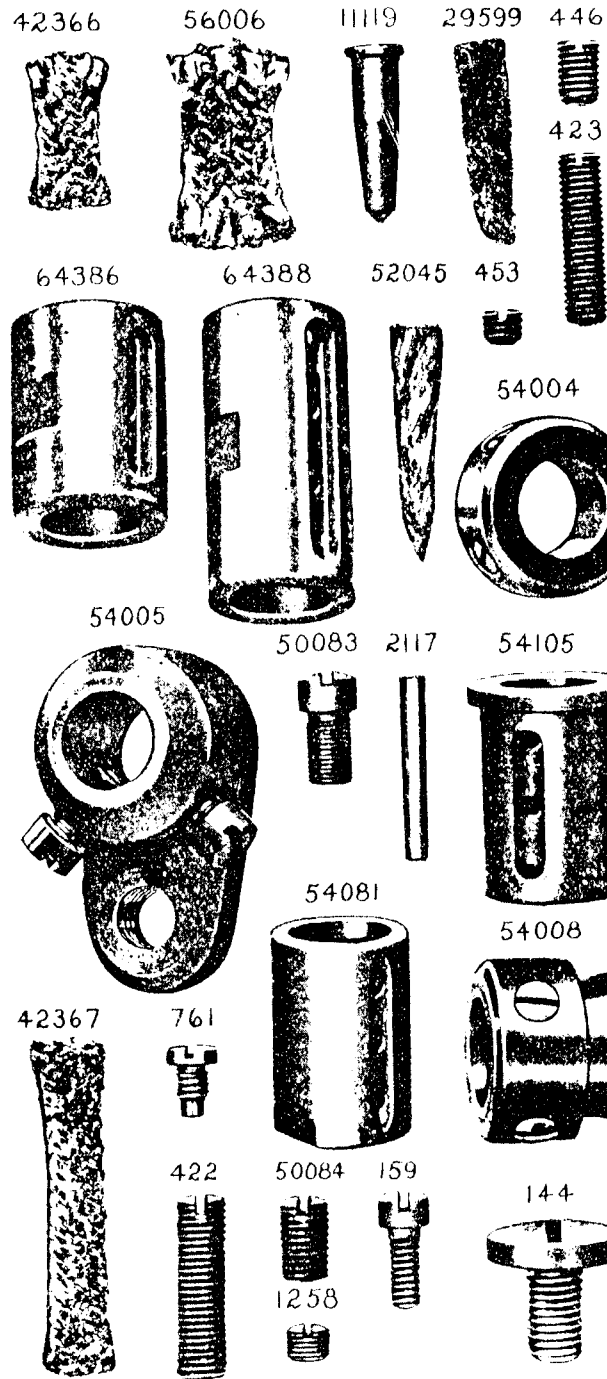
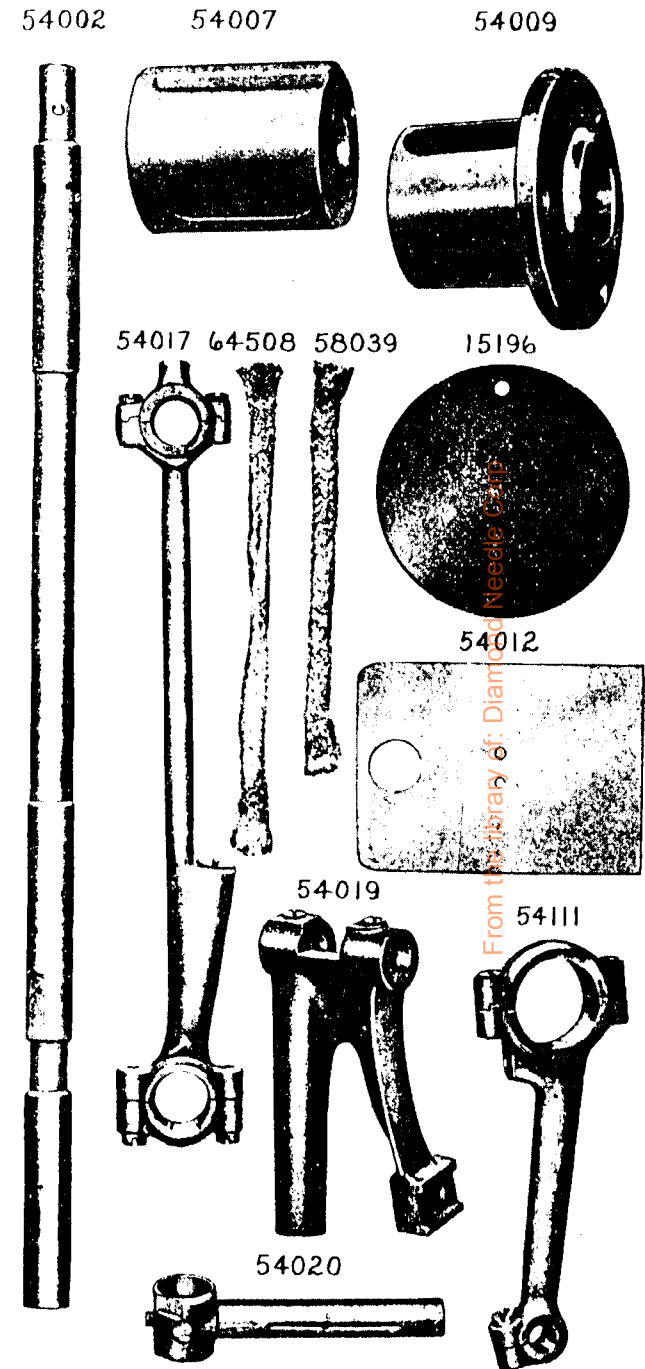

PLATE 8902—ONE-HALF SIZE



From the Library of: Diamond Needle Corp.

PLATE 8903—ONE-FOURTH SIZE

54011

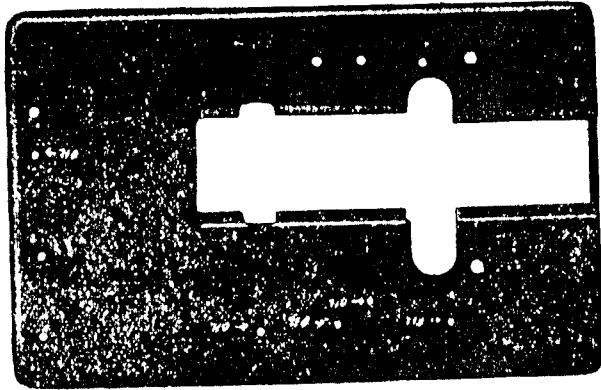

54006

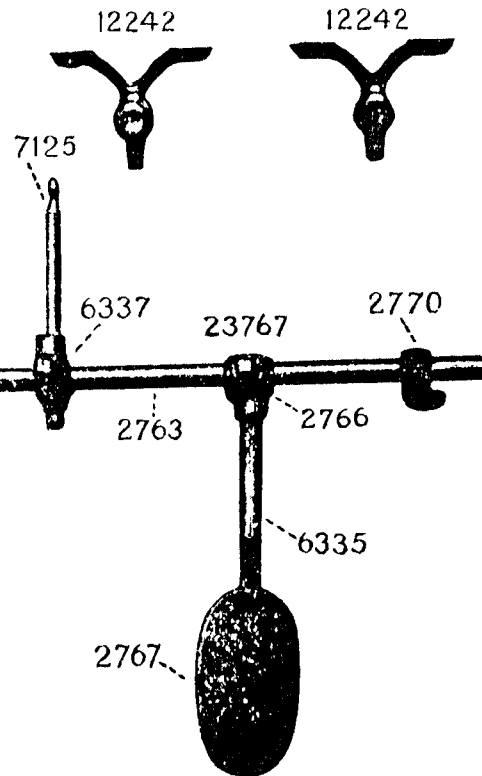

12242

12242

7125

6337

23767

2770

2763

2766

6335

2767

PLATE 8904—FULL SIZE

49013



286



54010



430



50473



1011



38419

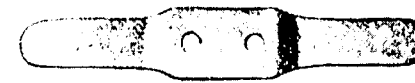

725

1235

From the library of the U.S. Army Medical Dept.

50069



1516



64268



896



1057



54897



57225



21506



457

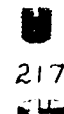

54218



6575



443



7071



50429



61171



1103



157



21332



934



PLATE 8905—ONE-HALF SIZE

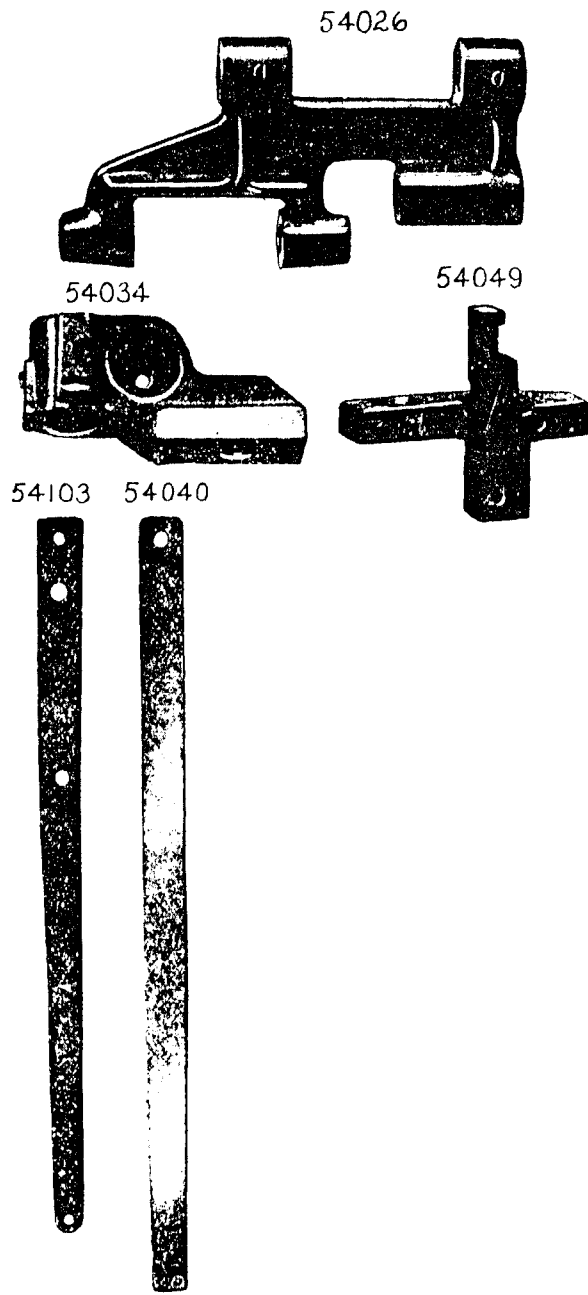

PLATE 8906—FULL SIZE

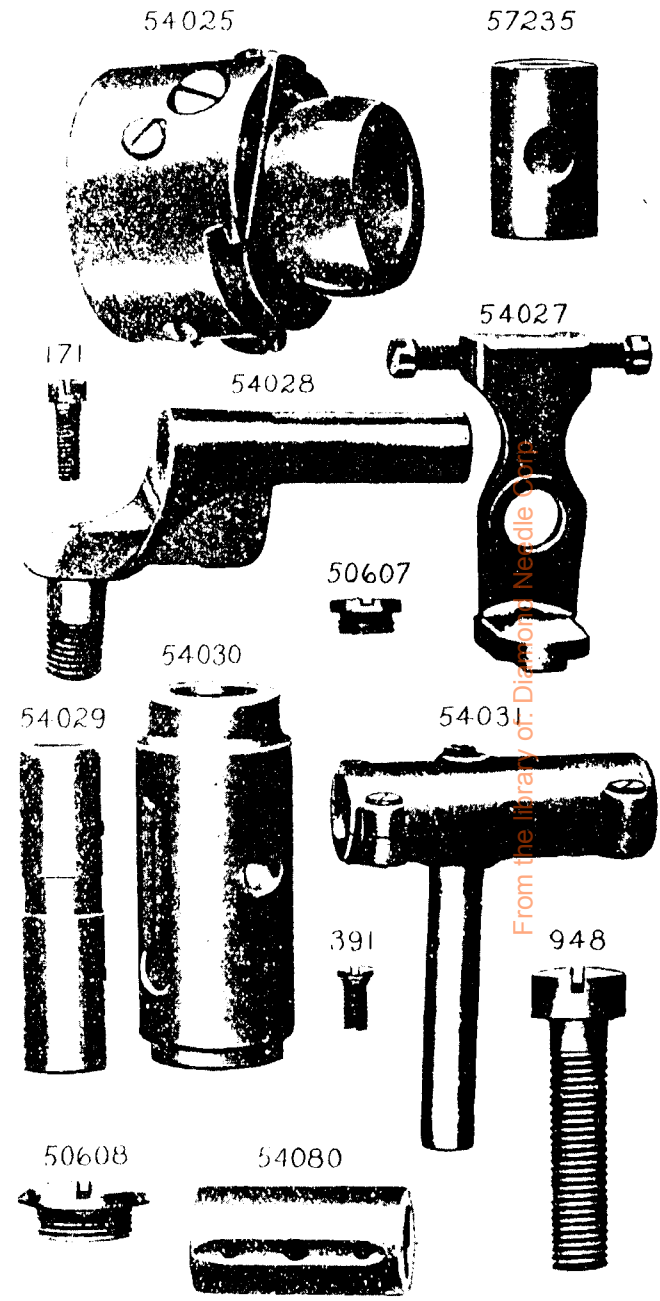

PLATE 8907—FULL SIZE

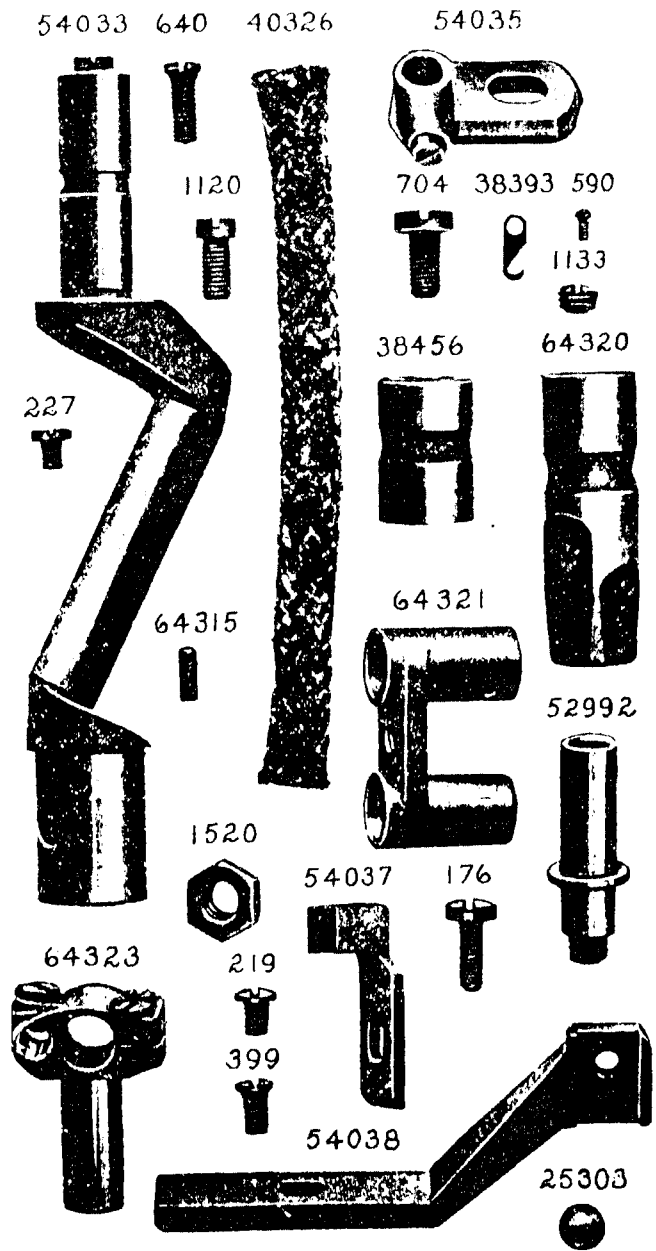

PLATE 8908—FULL SIZE

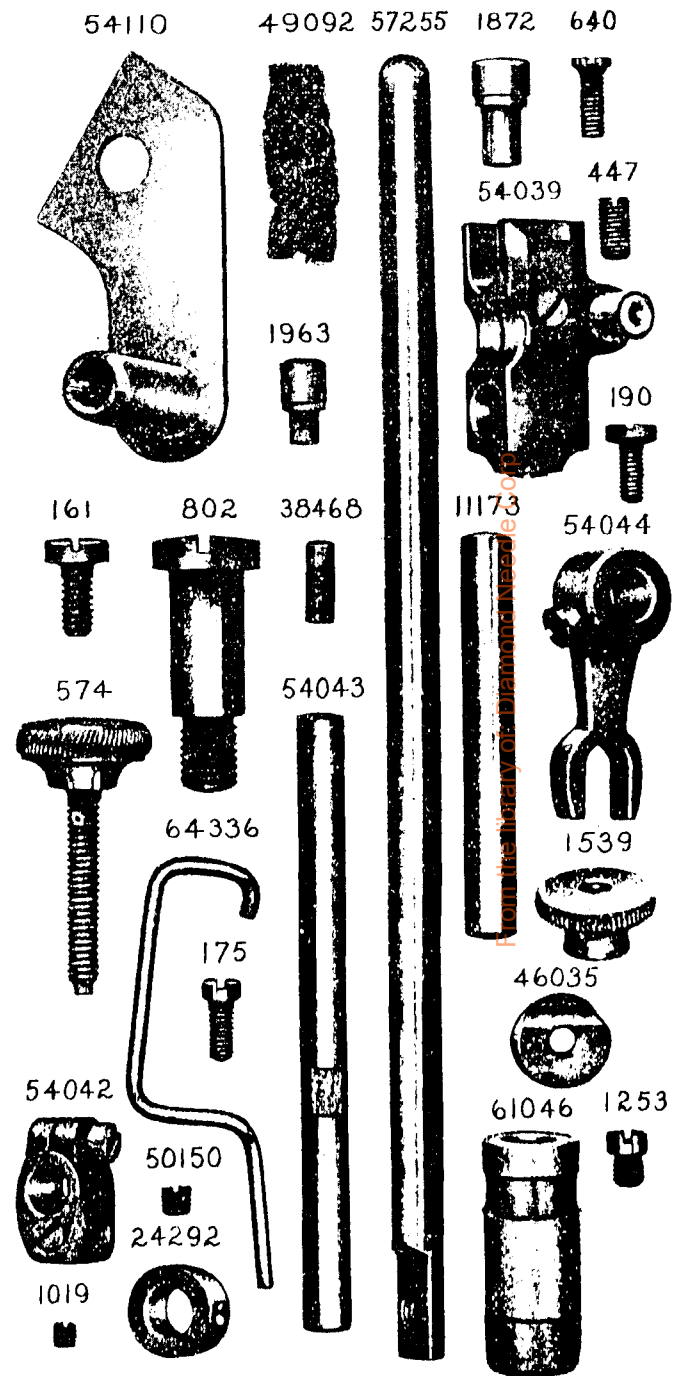

PLATE 8909—FULL SIZE

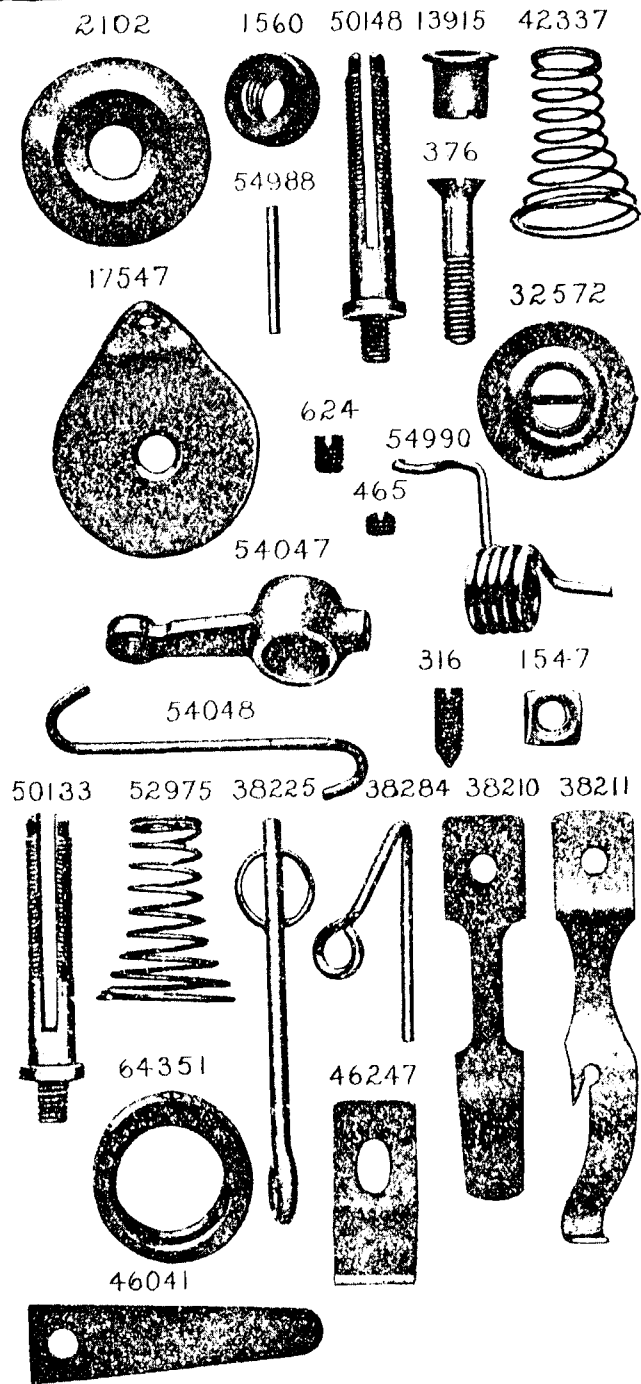
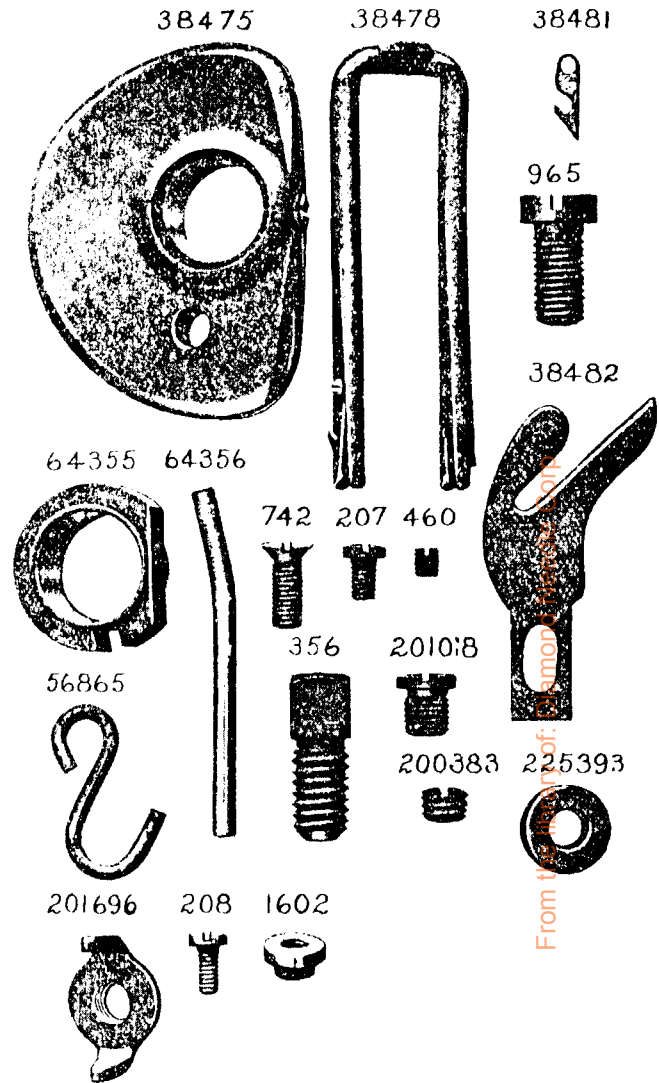

PLATE 8910—FULL SIZE



From the file of the Samoyed...

PLATE 8911—FULL SIZE

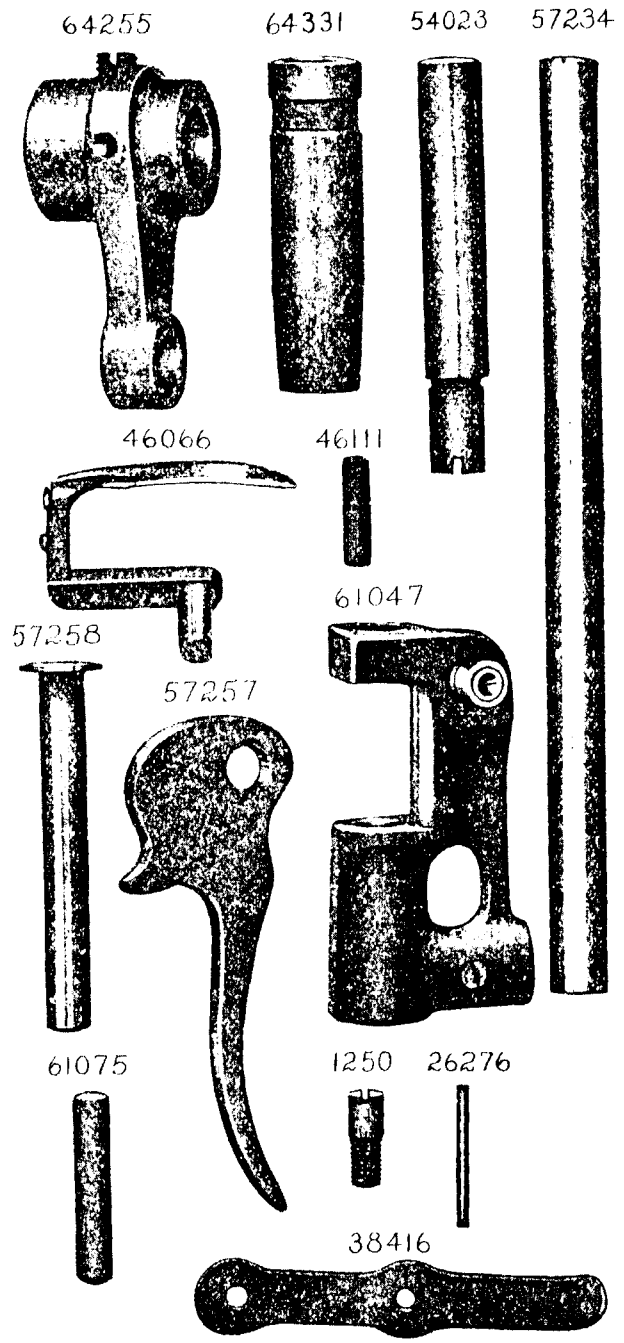

PLATE 8913—ONE-HALF SIZE

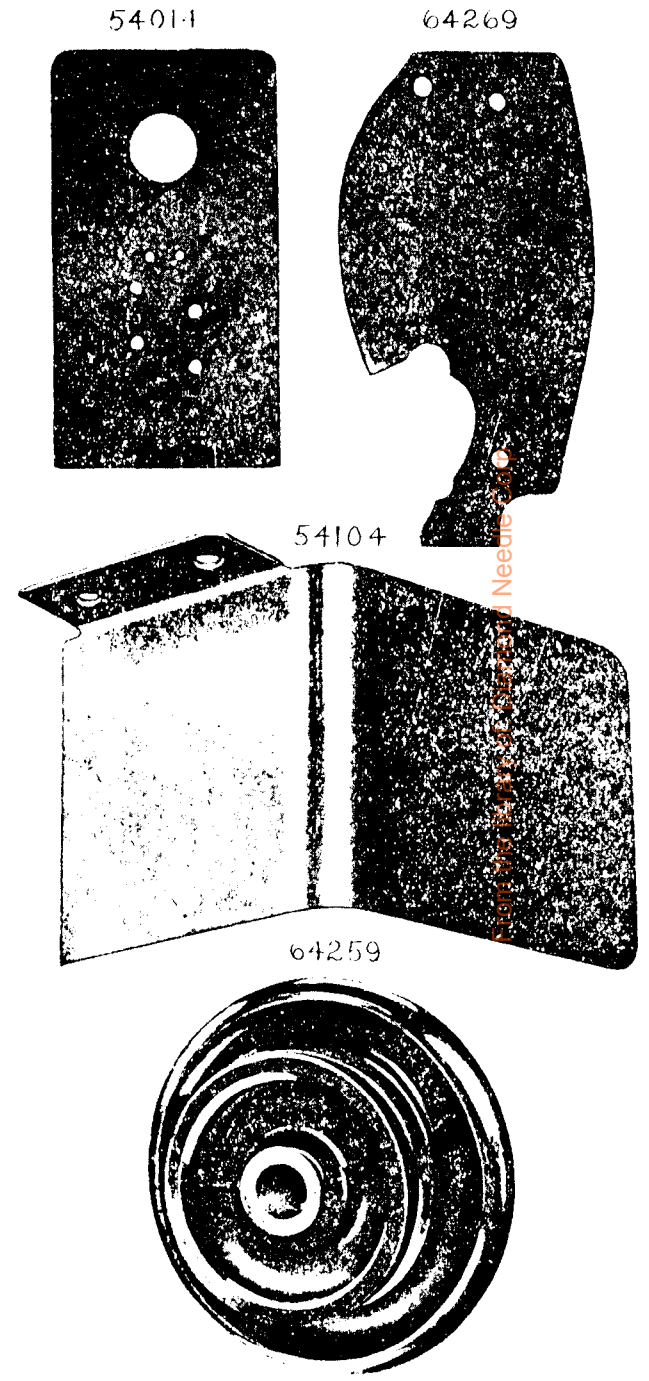

PLATE 8918—ONE-HALF SIZE

64330 64362

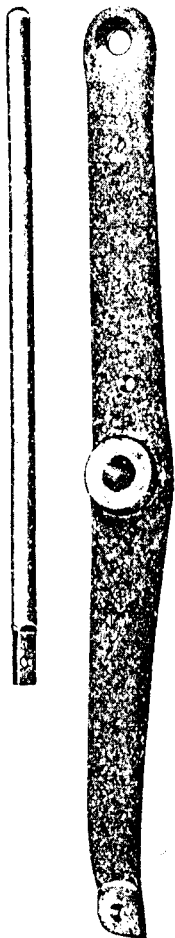
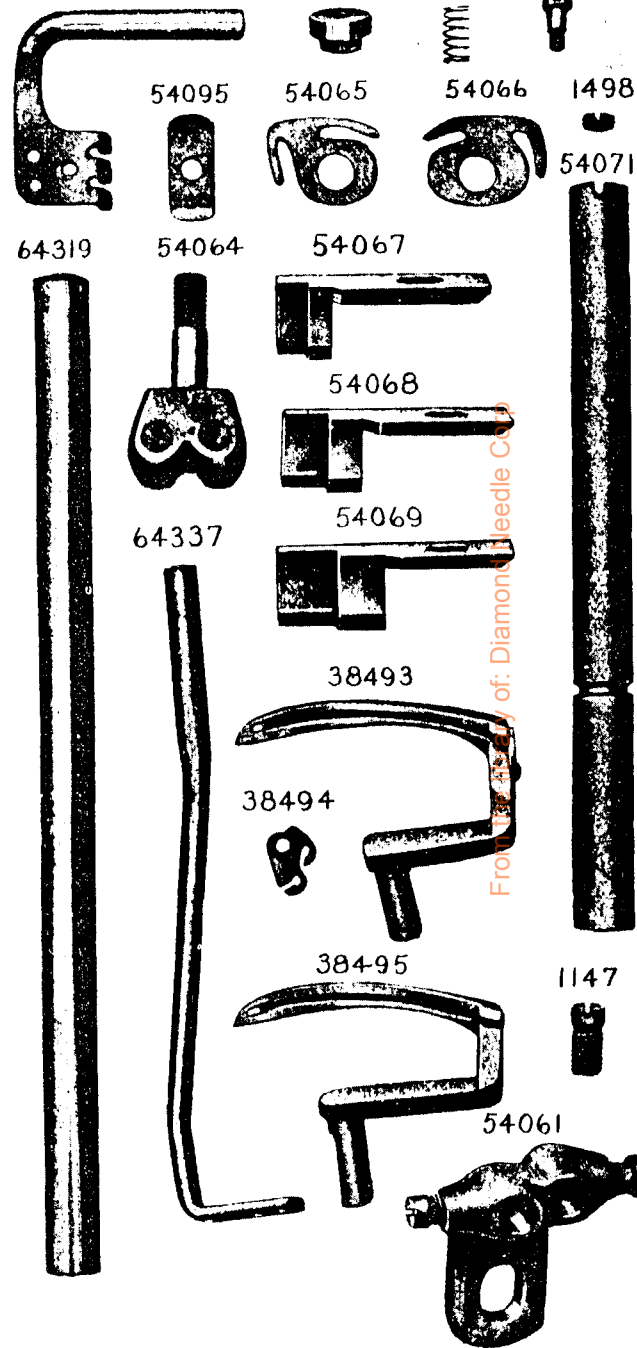

PLATE 8922—FULL SIZE

54094 1602 54716 1449



From the Library of: Diamond Needle Club

PLATE 8924—ONE-HALF SIZE

54055

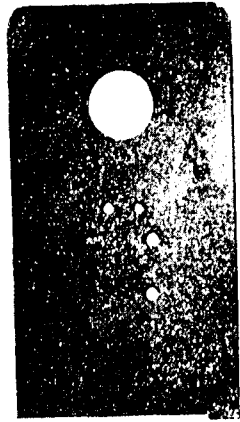

54057

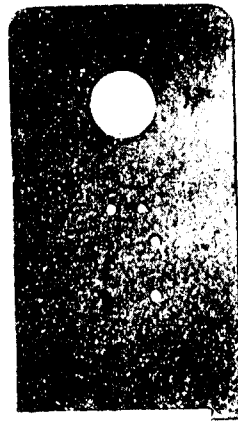

54210

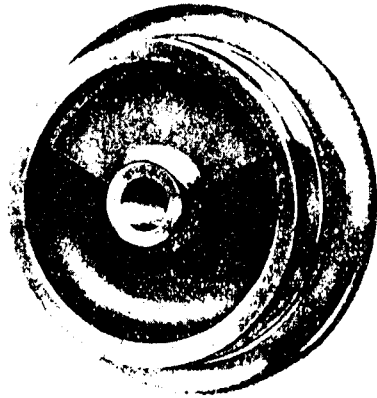
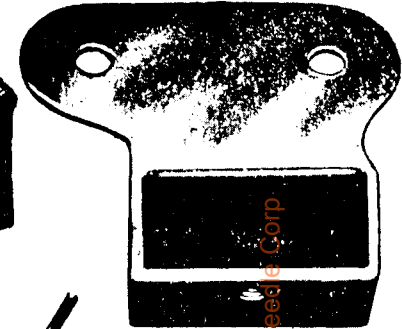

PLATE 8931—FULL SIZE

54070



54204



57629



54205



54072

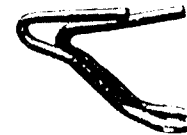

46009



64357



46047

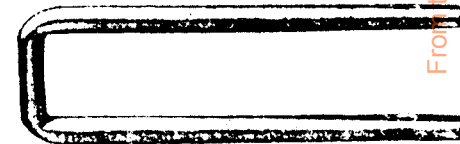

From the library of Diamond Needle Corp

PLATE 8932—ONE-HALF SIZE

54183

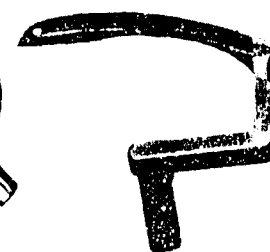
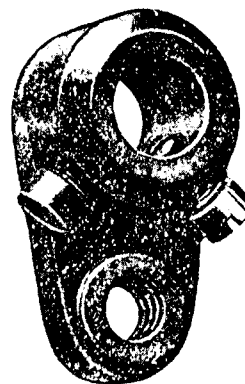

PLATE 8933—FULL SIZE

54186

54184

54106



54107

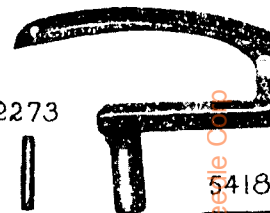

46166

462

2273



46070

2026

38100

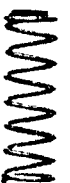

46088

54203

54201



54188

242

1423

1284



1284

Join the library of Diamond Needle Corp

PLATE 8934—FULL SIZE

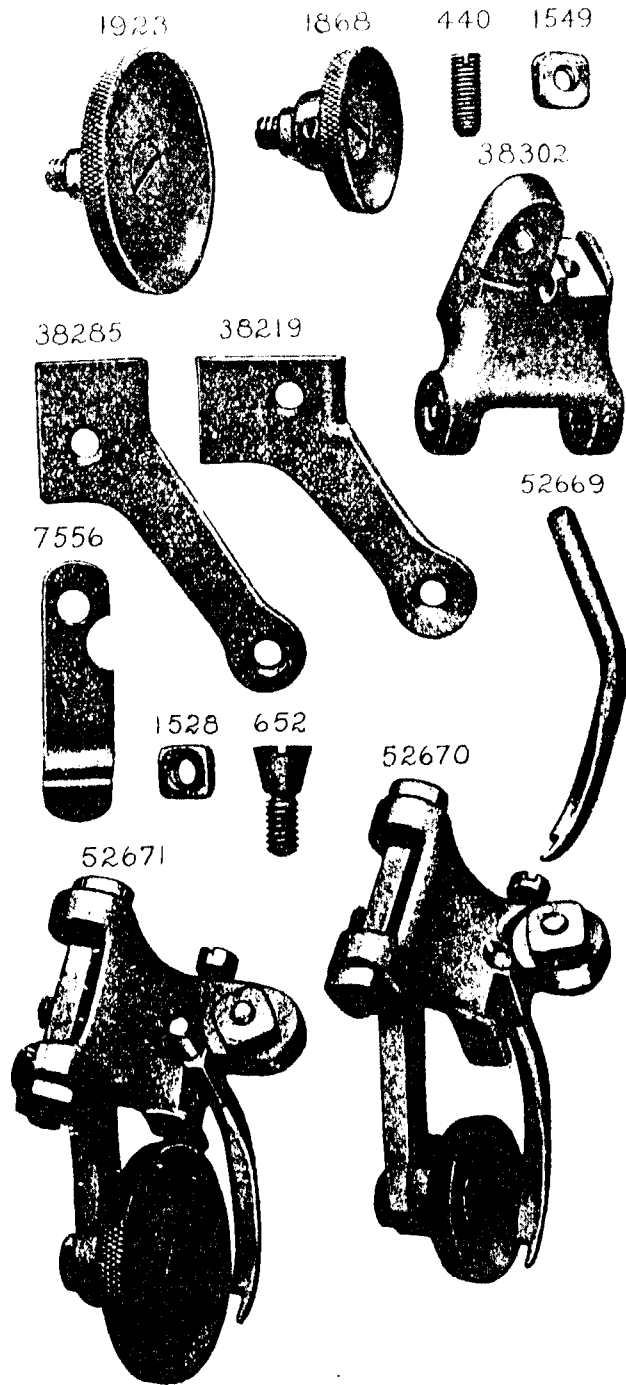
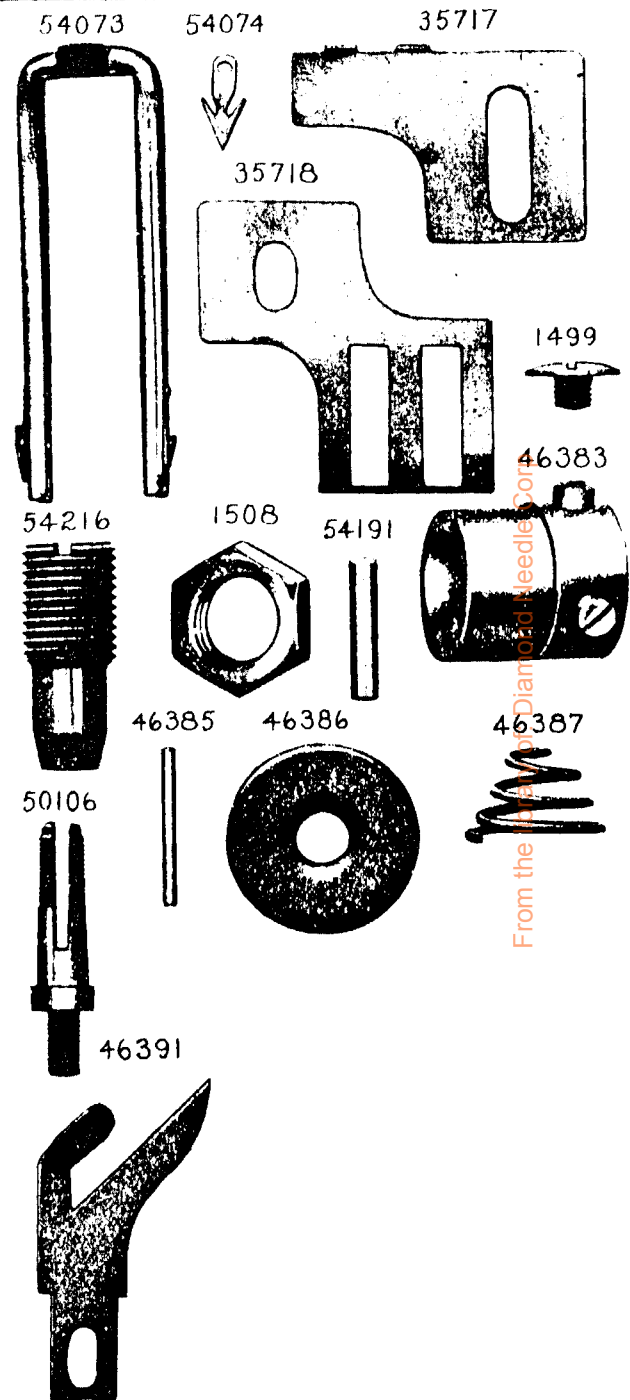

PLATE 8935—FULL SIZE



From the [Diamond Needle Co.](#)

PLATE 8936—FULL SIZE

46089

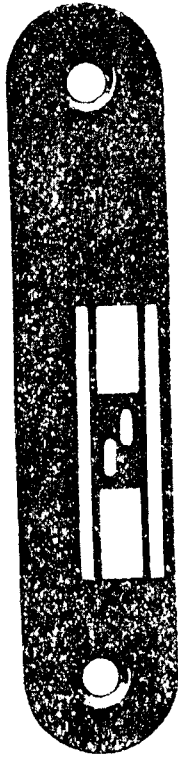

46080



46090

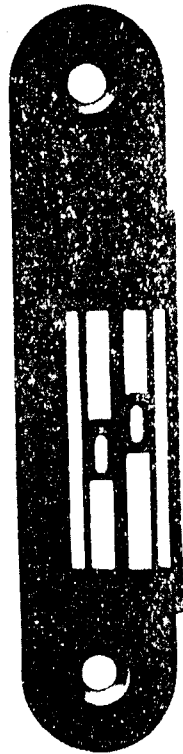

46081



PLATE 8937—FULL SIZE

46011



38492



46074

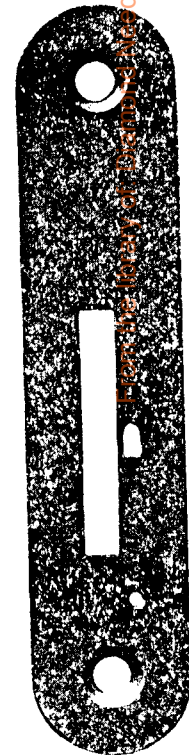

54185



46075



665



Copyright © 2010 by the American Society of Mechanical Engineers

PLATE 8938—ONE-FOURTH SIZE

54199

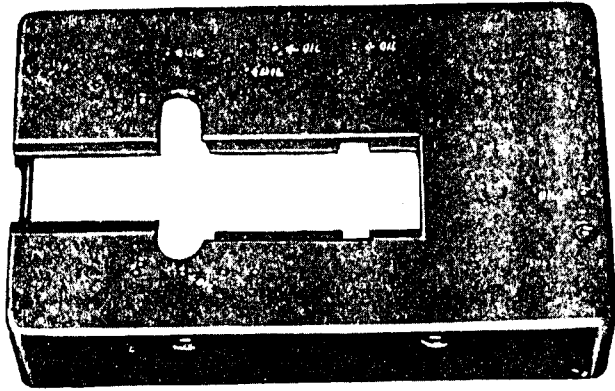

54006



54183



28994

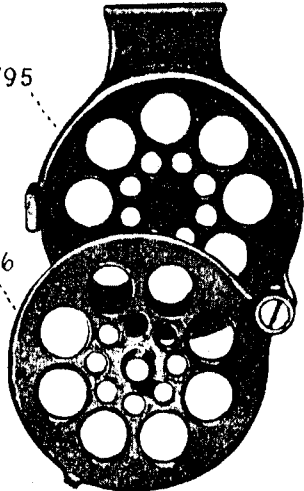

36795

36796

54104

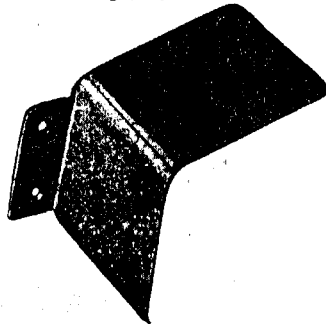
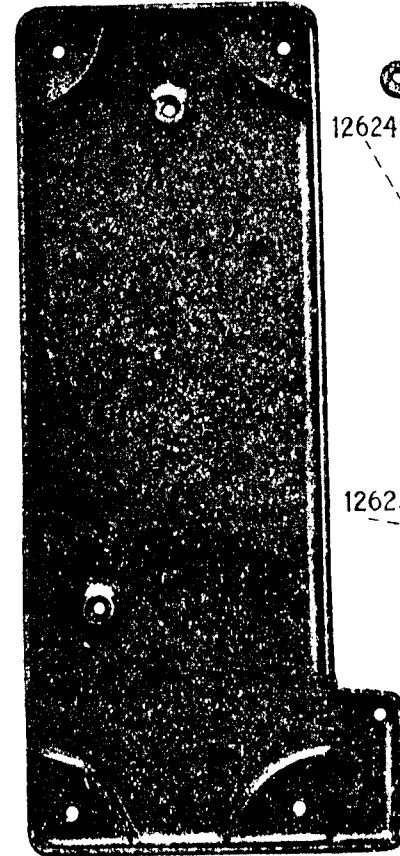

PLATE 8939—ONE-FOURTH SIZE

54091



126252

126249

126251

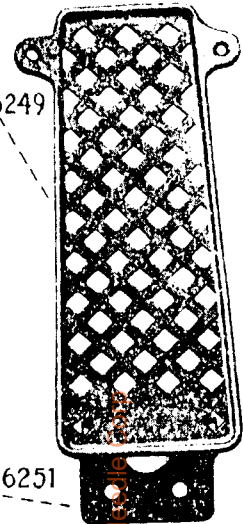

54052



From the library of: Diamond N

PLATE 8940—FULL SIZE

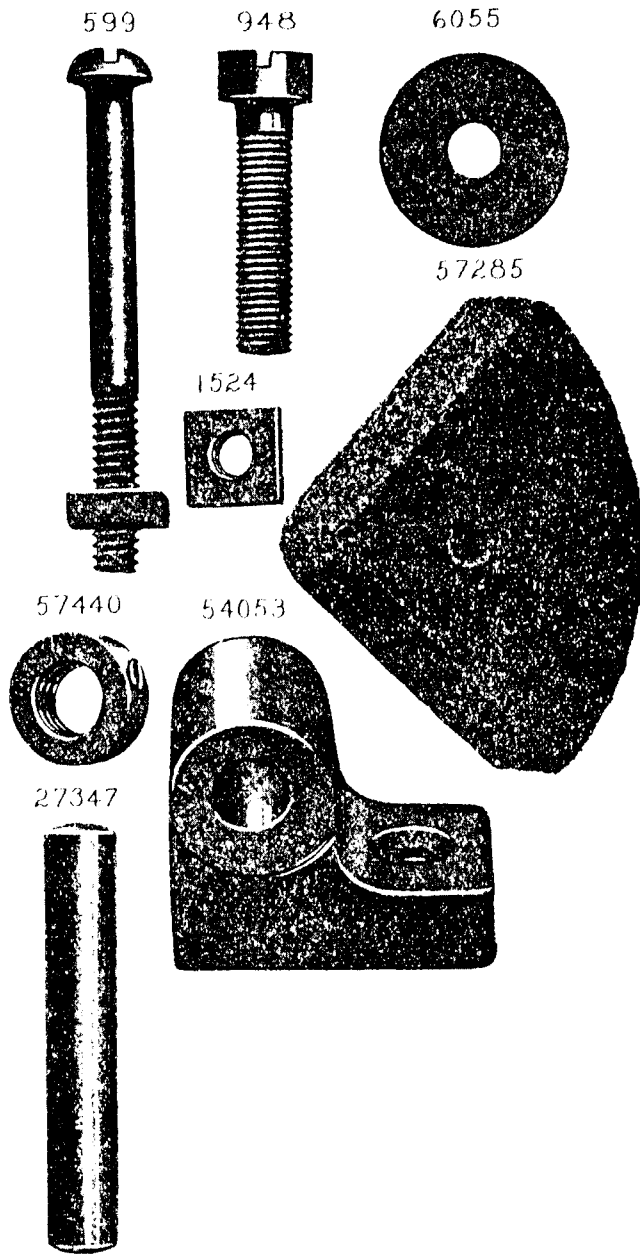
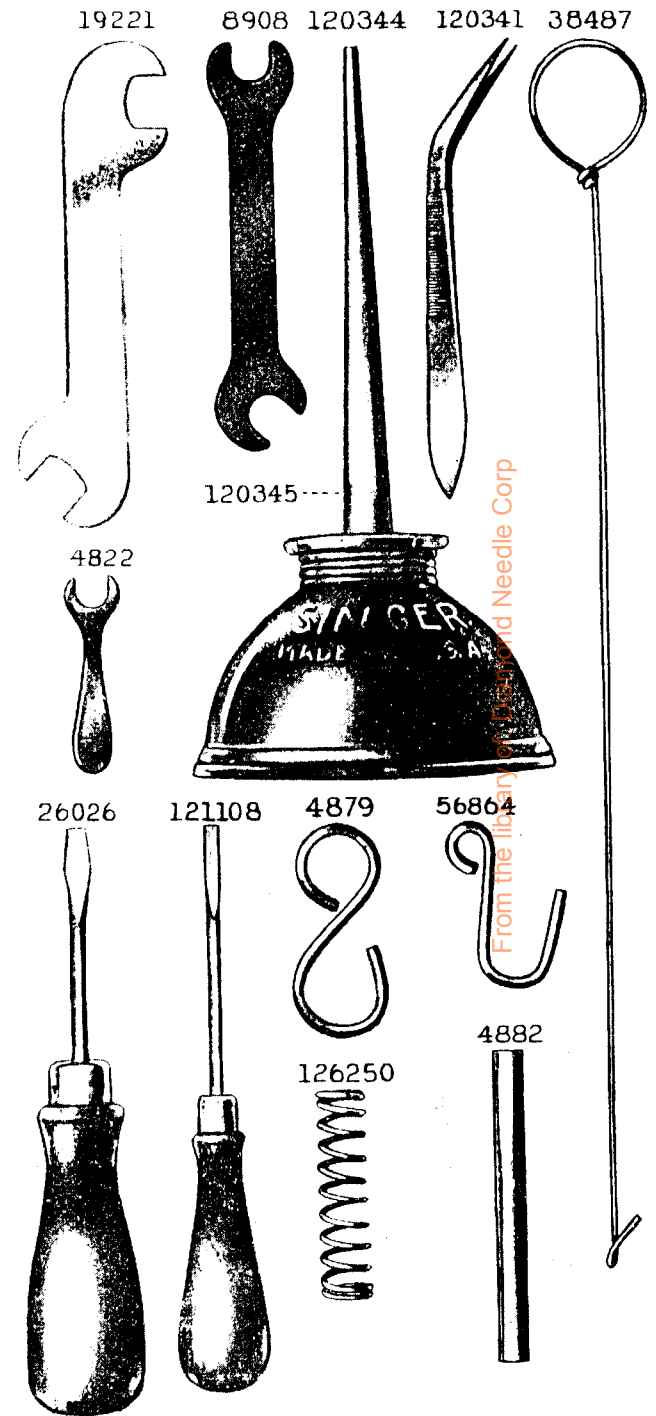

PLATE 8941—ONE-HALF SIZE



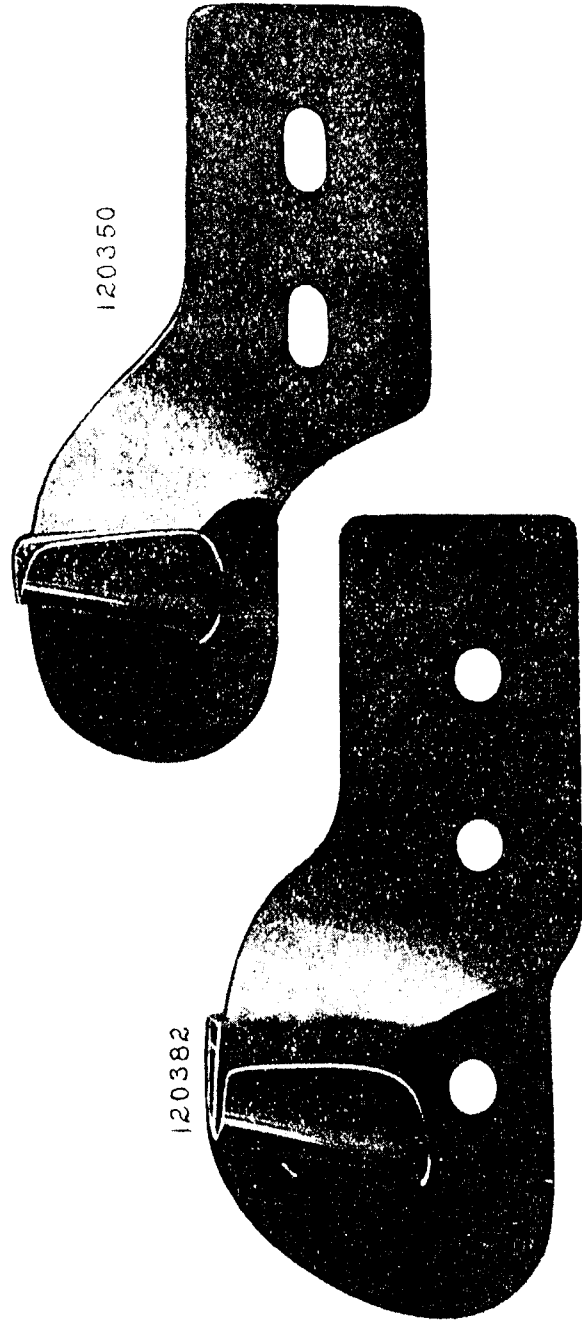

PLATE 8948—FULL SIZE

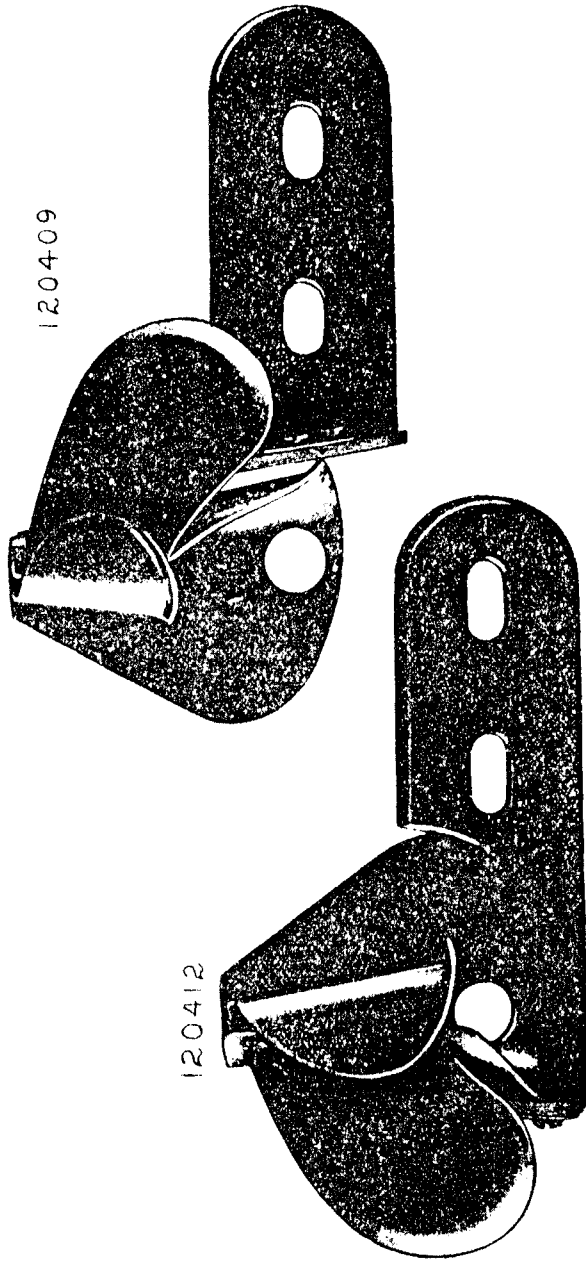

PLATE 8949—FULL SIZE

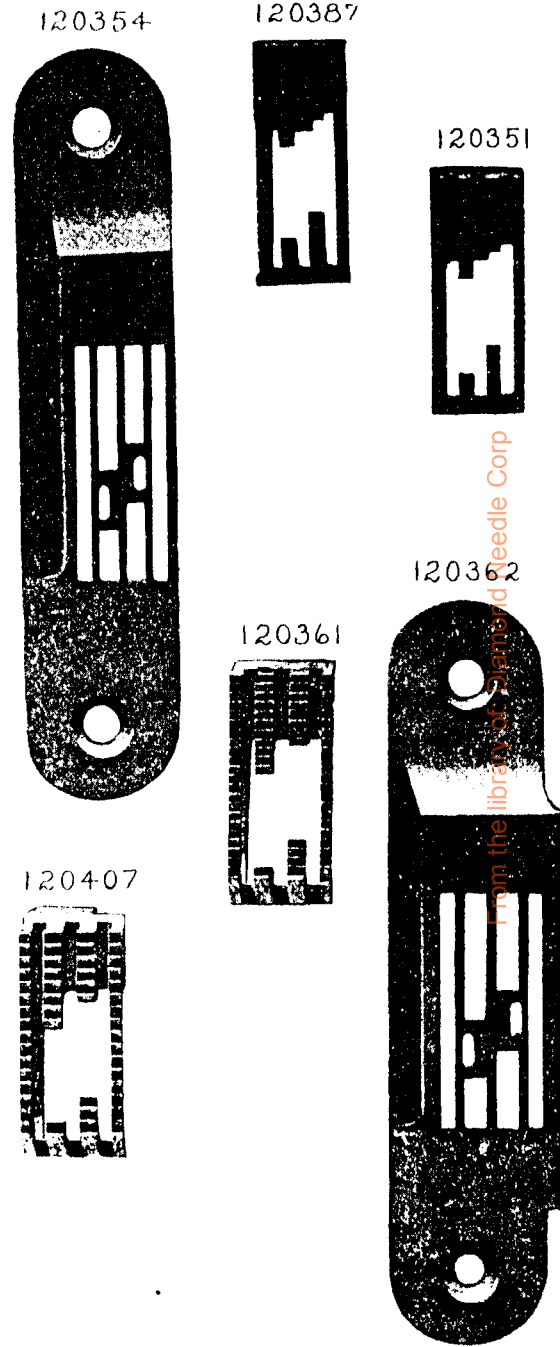
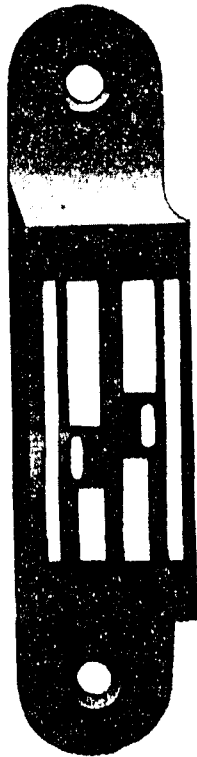

PLATE 8950—FULL SIZE

120386



120383



54097



54099



54100



54098



54114



PLATE 8951—FULL SIZE

120353



120385



120406



54121



54118



54102



From the library of: [Harvard Medical School](#)

PLATE 8952—FULL SIZE

9370



126247



124500

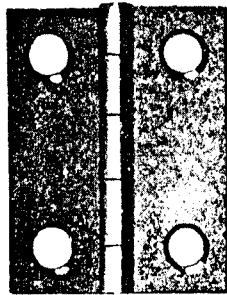

126248



5604



27998



60656

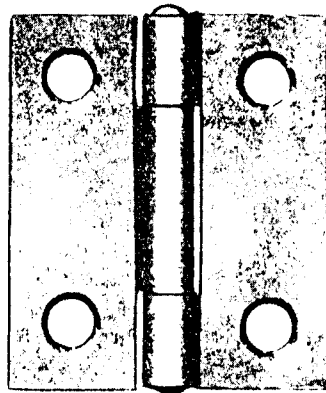
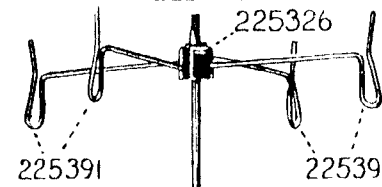

PLATE 8953—ONE-FOURTH SIZE

225398

225326



225391

225391

225324

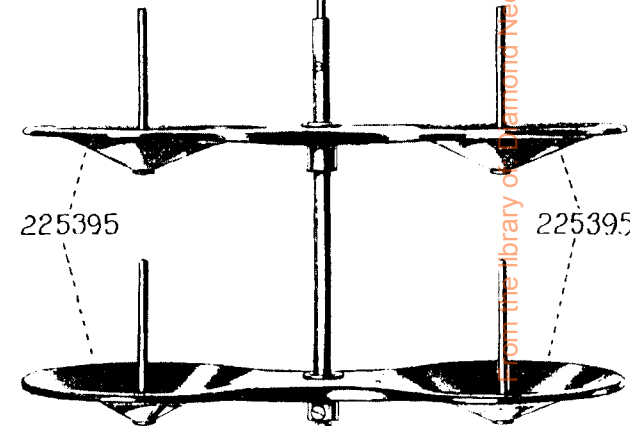

225395

225395

225388

202490

on the library of the Diamond Needle Corp